

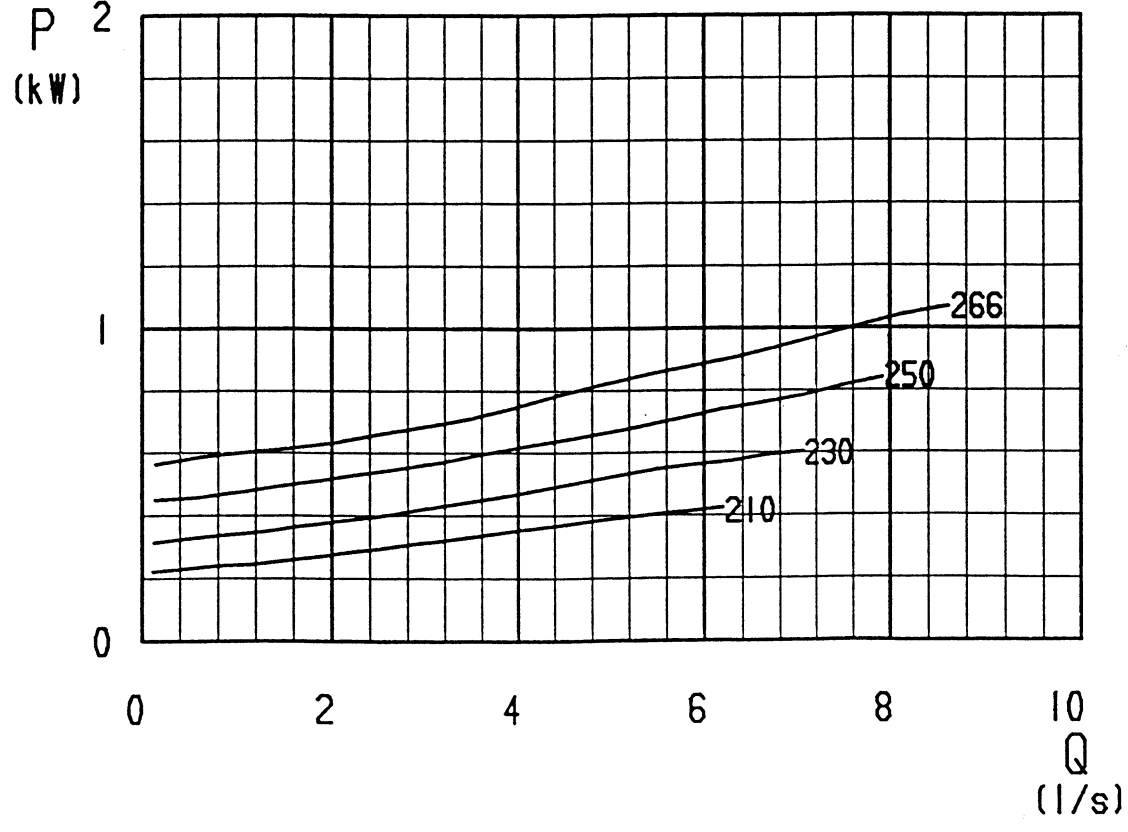

## Index

Pump type	Speed	Curve no.	Page no.
11-50	1430	K 000410	11
	2905	K 000412	23
21-65	1480	K 00414	12
	2905	K 00416	24
22-50	940	K 001972	1
	1480	K 000422	13
	2950	K 000424	25
22-65	940	K 002344	2
	1480	K 000426	14
	2950	K 000428	26
22-80	980	K 001083	3
	1480	K 000430	15
	2950	K 000433	27
31-100	960	K 02575	4
	1480	K 00436	16
	2950	K 00438	28
31-150	980	K 00446	5
	1480	K 00448	17
32-65	950	K 01973	6
	1480	K 00450	18
32-80	960	K 02577	7
	1480	K 00453	19
32-100	980	K 001133	8
	1480	K 000457	20
32-125	980	K 00461	9
	1480	K 00464	21
42-150	980	K 00710	10
	1480	K 00712	22

Pump type : <b>APP 22 - 50</b>	Nominal speed : <b>940 rpm</b>	<b>KSB</b> 
Curve no. : K 001972	Frequency : <b>50 Hz</b>	

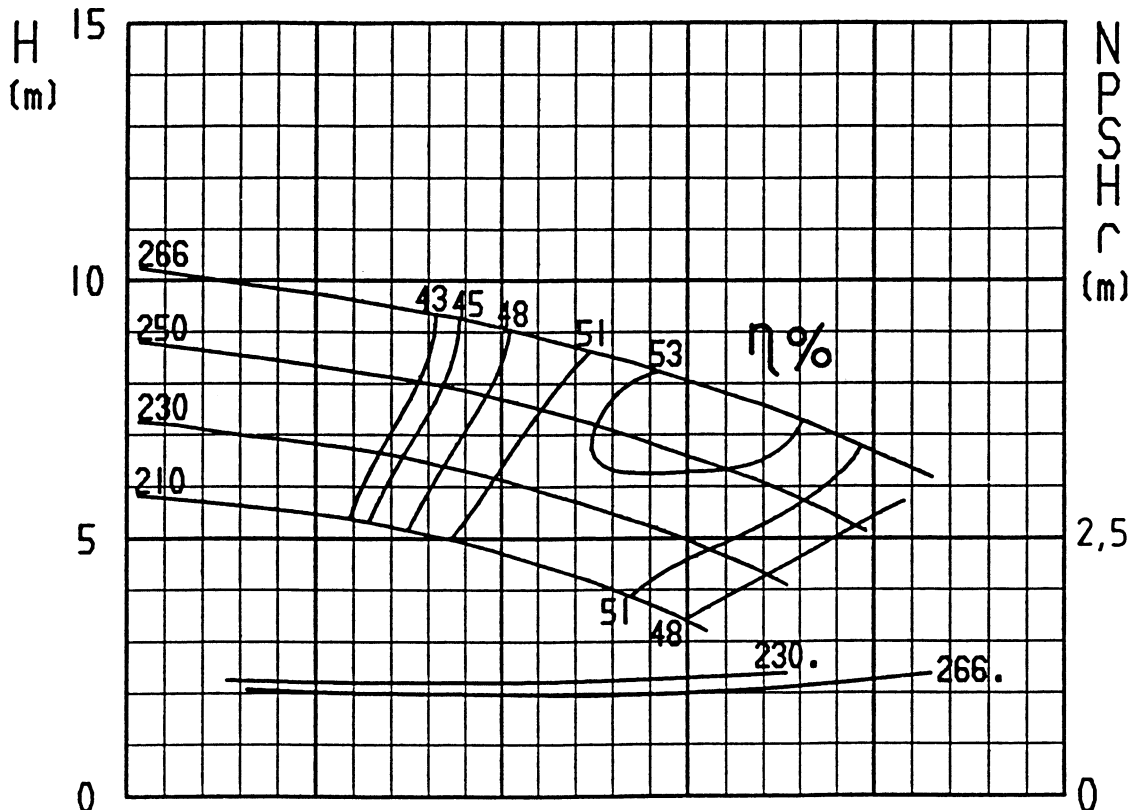

Pump type : <b>APP 22 - 65</b>	Nominal speed : <b>940 rpm</b>	
Curve no. : K 002344	Frequency : <b>50 Hz</b>	

$n = 940 \text{ rpm}$

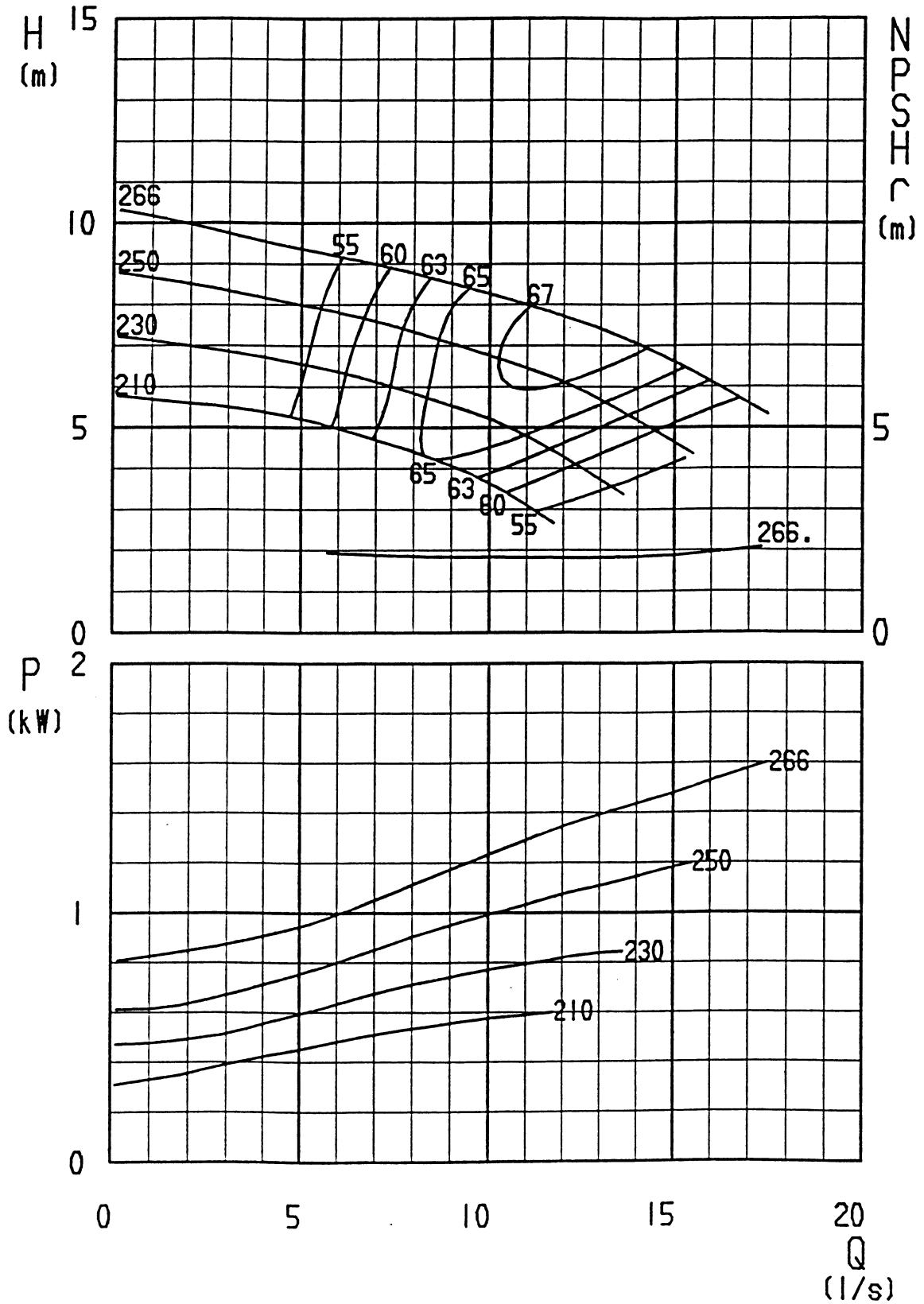

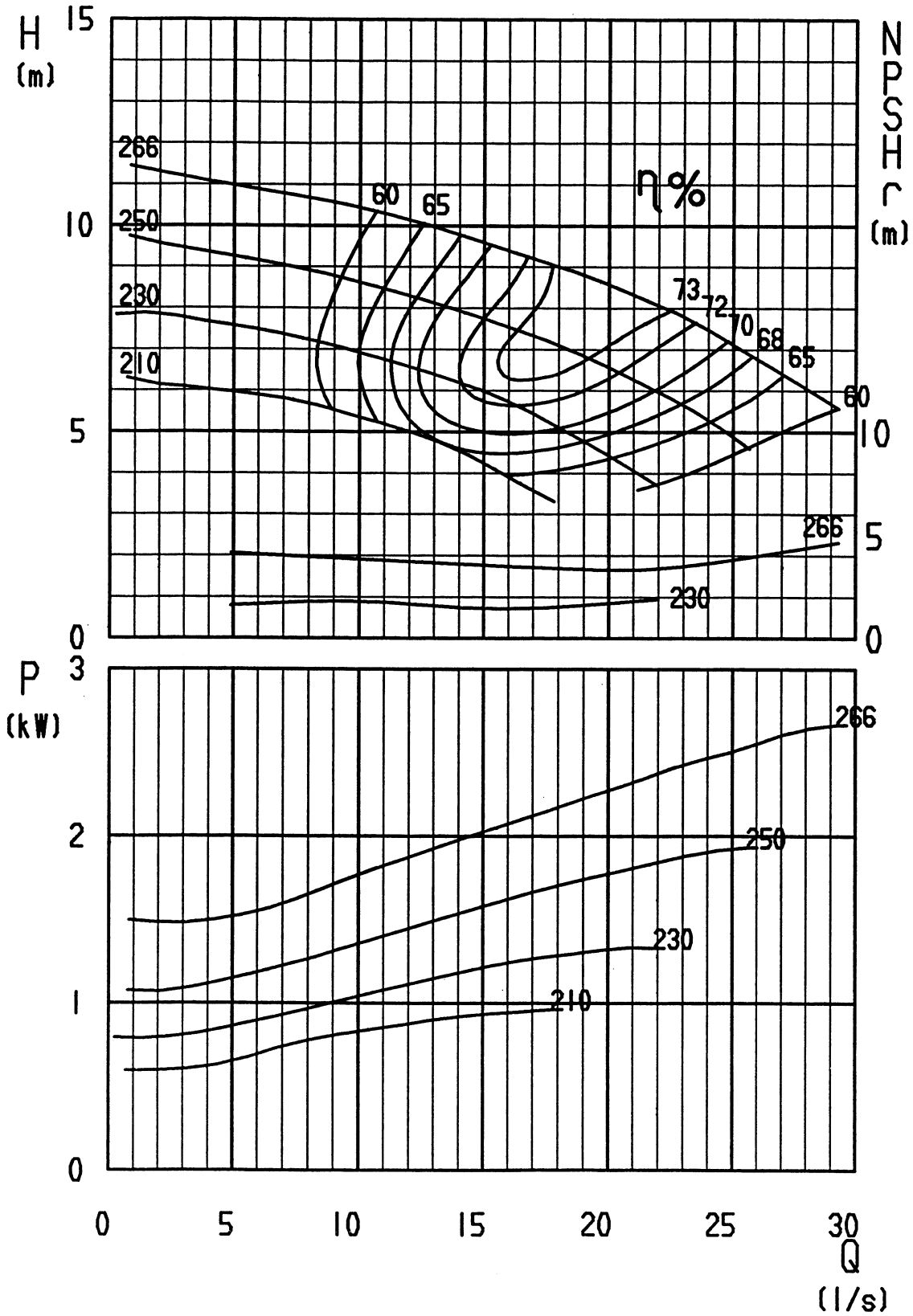

Pump type : <b>APP 22 - 80</b>	Nominal speed : <b>980 rpm</b>	
Curve no. : K 001083	Frequency : <b>50 Hz</b>	

$n = 980 \text{ rpm}$

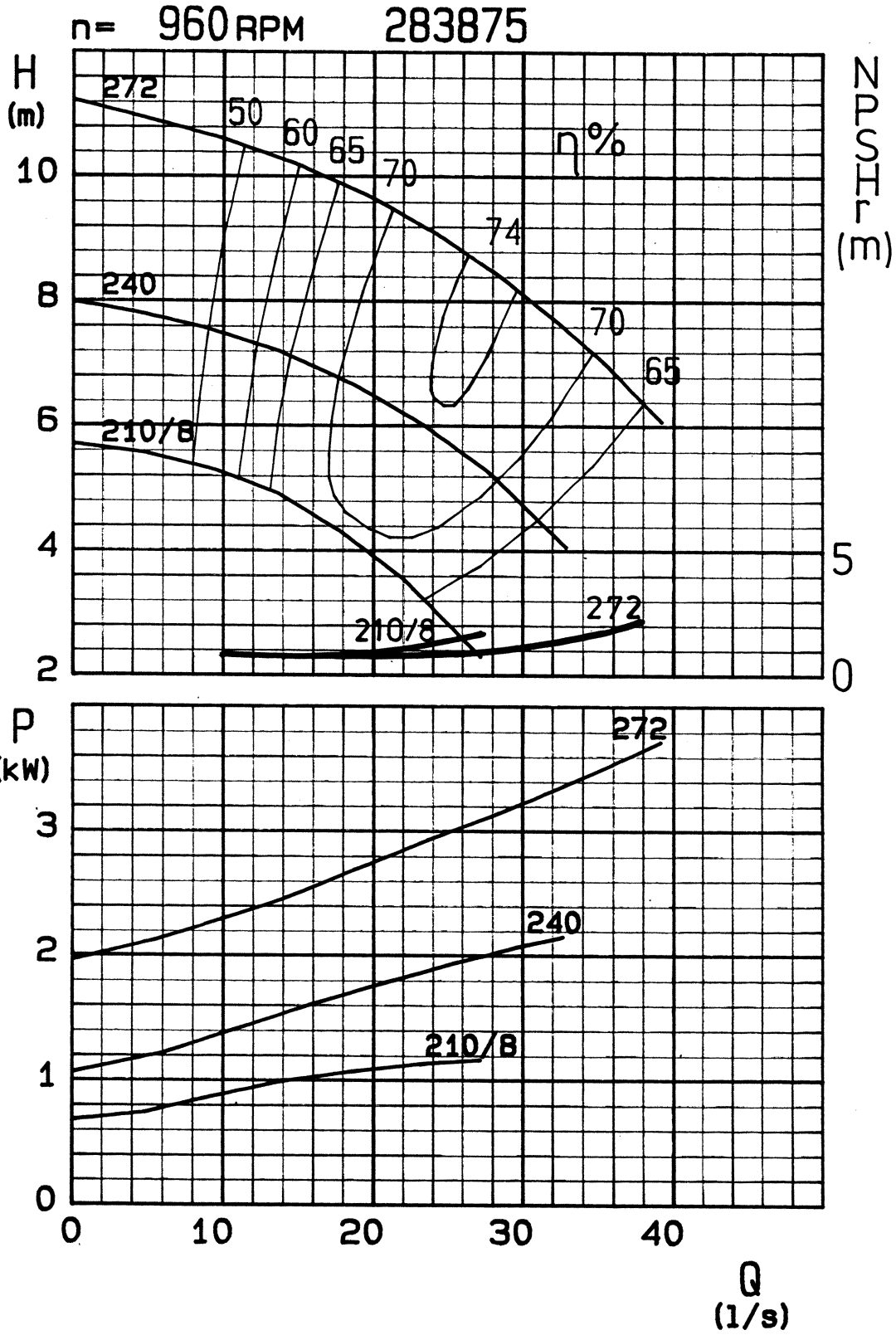

Pump type : <b>APP 31 - 100</b>	Nominal speed : <b>960 rpm</b>	
Curve no. : <b>K 02575</b>	Frequency : <b>50 Hz</b>	



Pump type : <b>APP 31 - 150</b>	Nominal speed : <b>980 rpm</b>	
Curve no. : K 00446	Frequency : <b>50 Hz</b>	

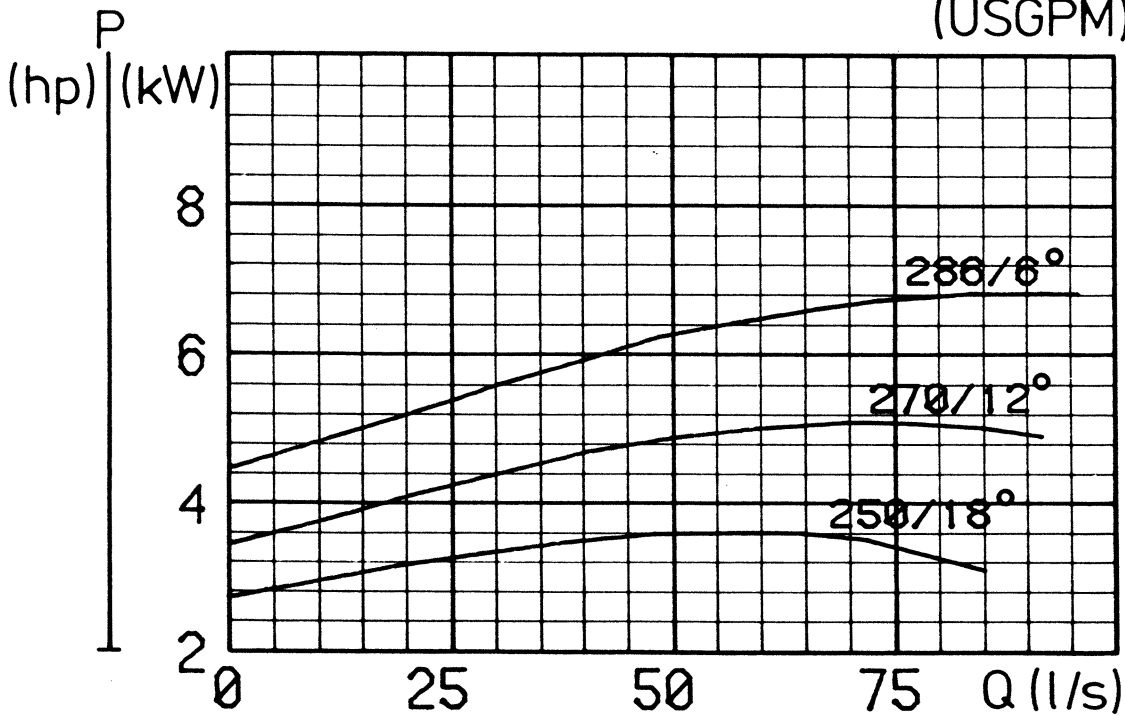
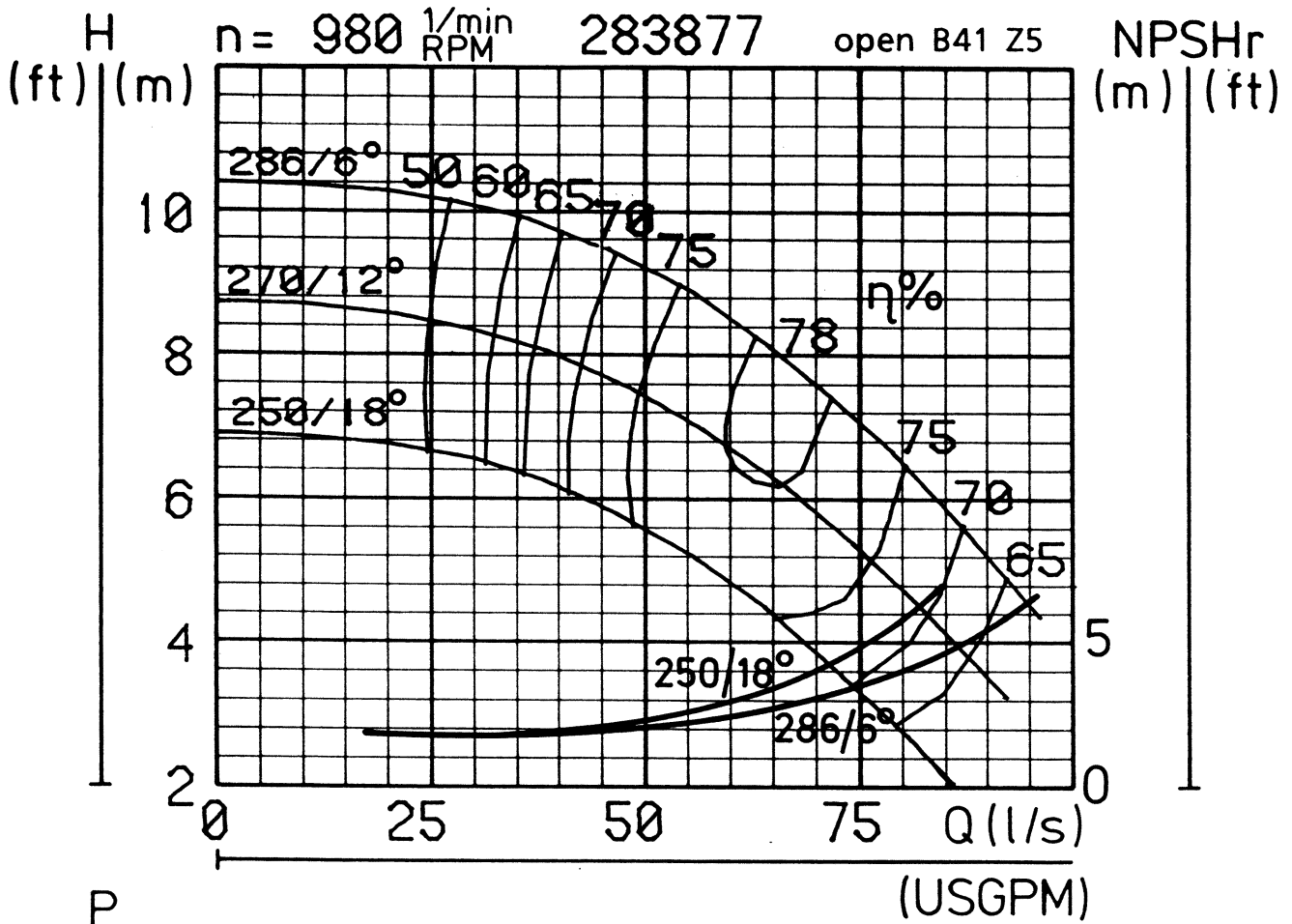

Pump type : <b>APP 32 - 65</b>	Nominal speed : <b>950 rpm</b>	
Curve no. : K 01973	Frequency : <b>50 Hz</b>	

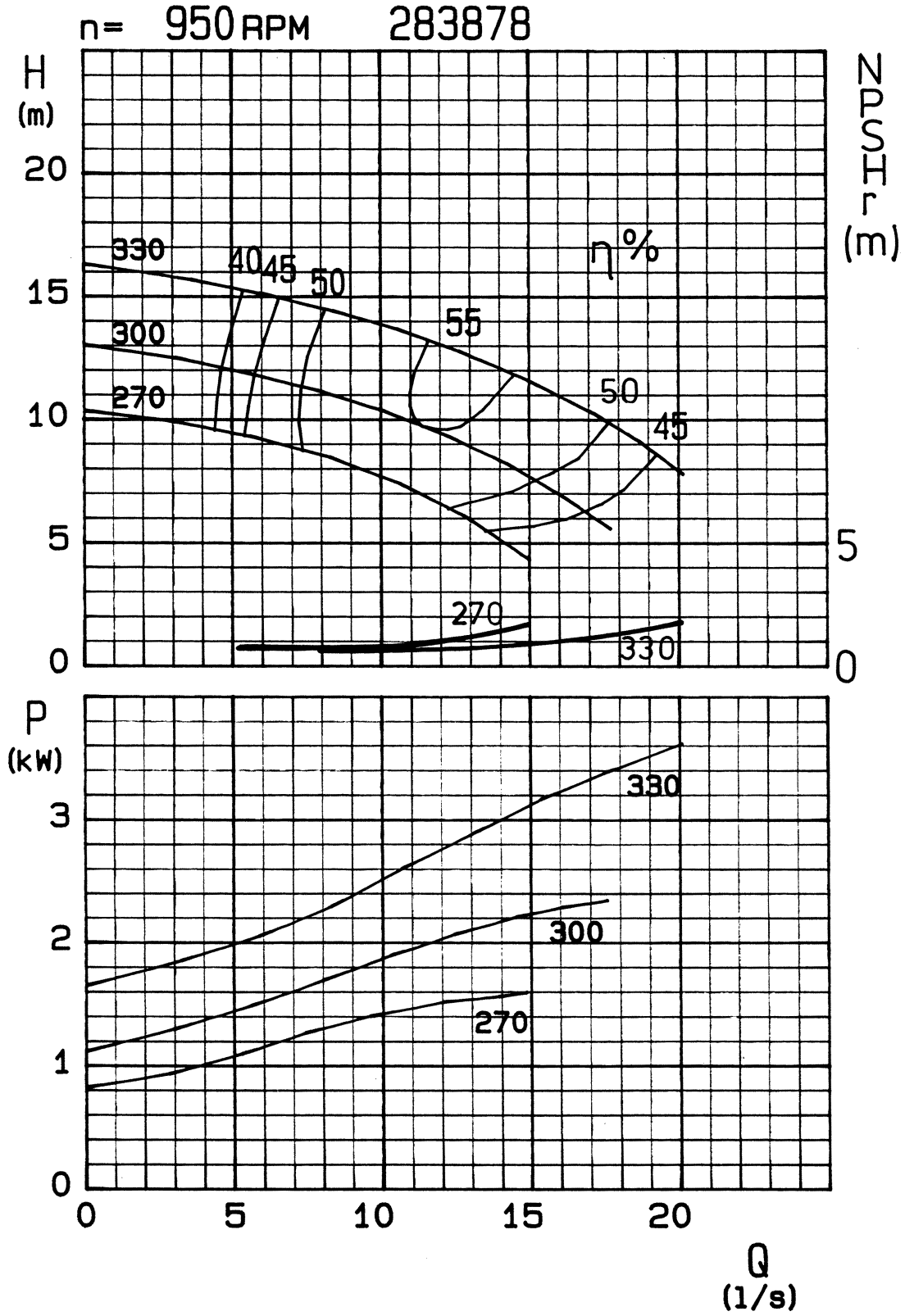

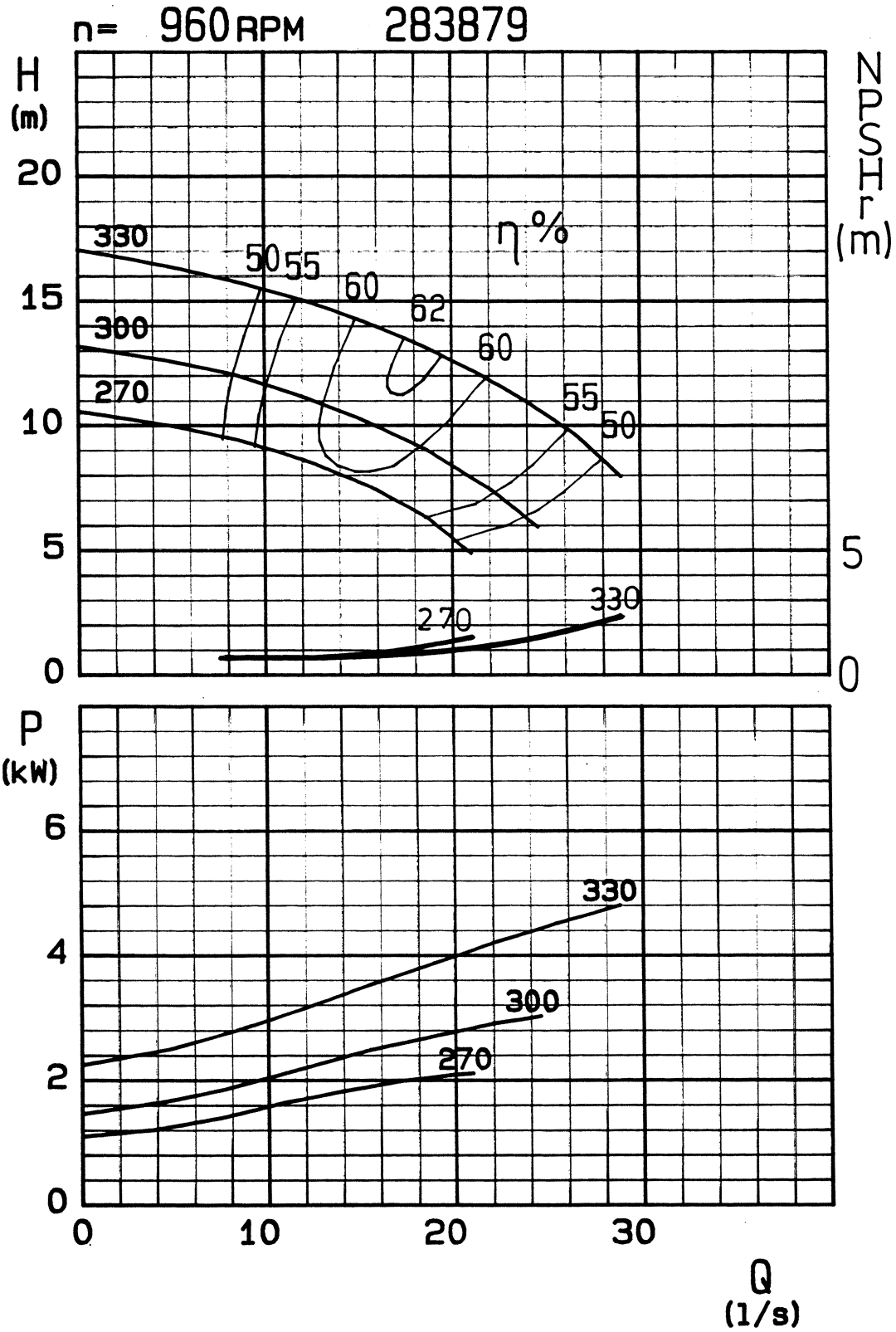

Pump type : <b>APP 32 - 80</b>	Nominal speed : <b>960 rpm</b>	<b>KSB</b> 
Curve no. : <b>K 02577</b>	Frequency : <b>50 Hz</b>	



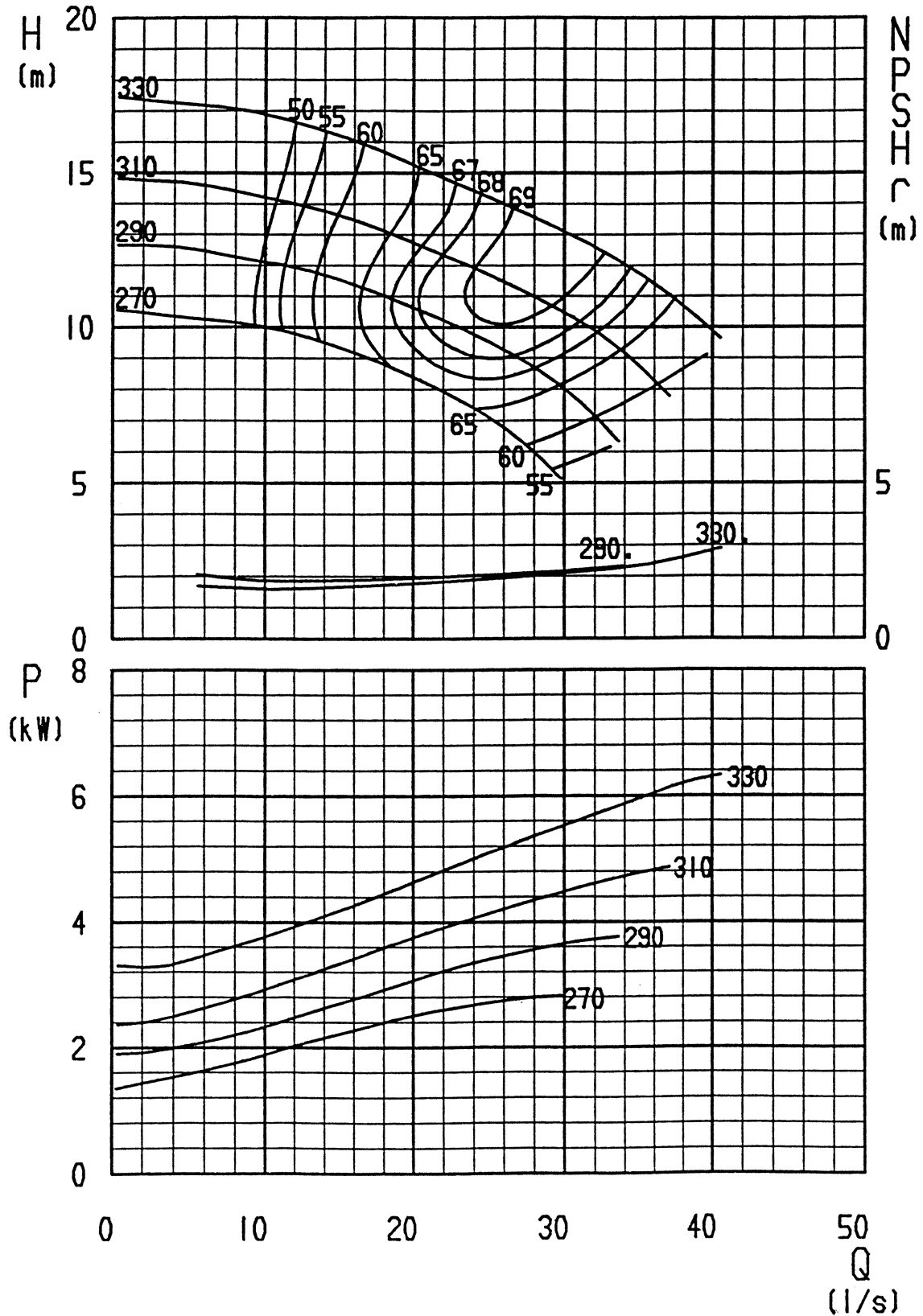

Pump type : <b>APP 32 - 100</b>	Nominal speed : <b>980 rpm</b>	<b>KSB</b> 
Curve no. : K 001133	Frequency : <b>50 Hz</b>	

$n = 980 \text{ rpm}$

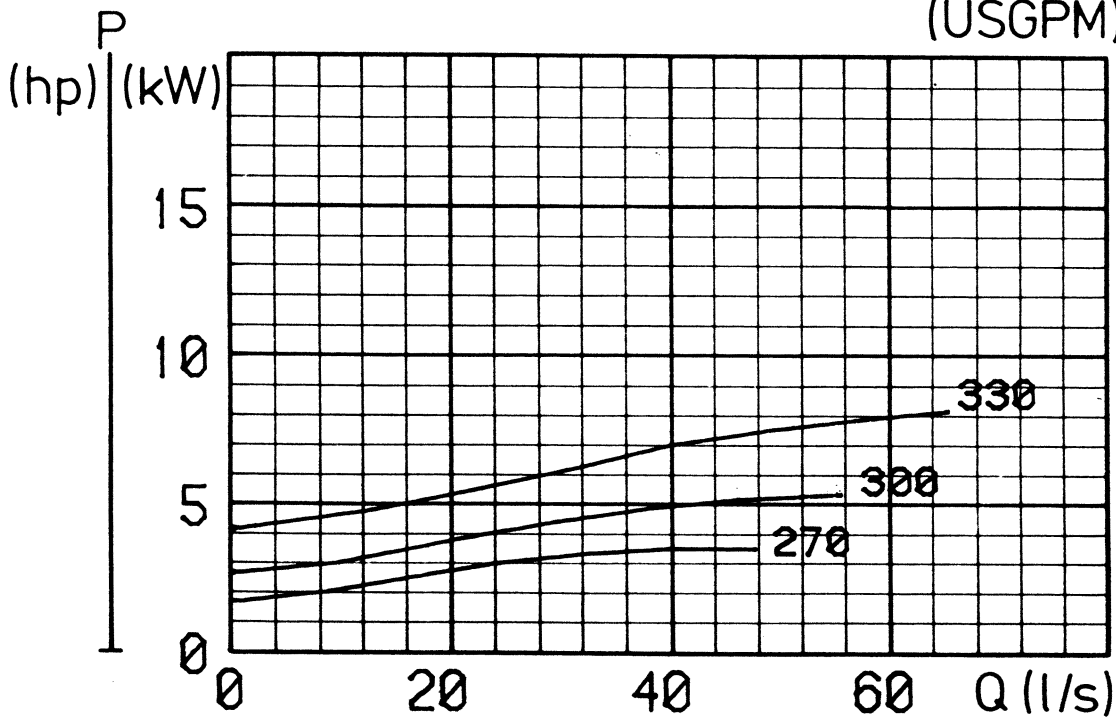
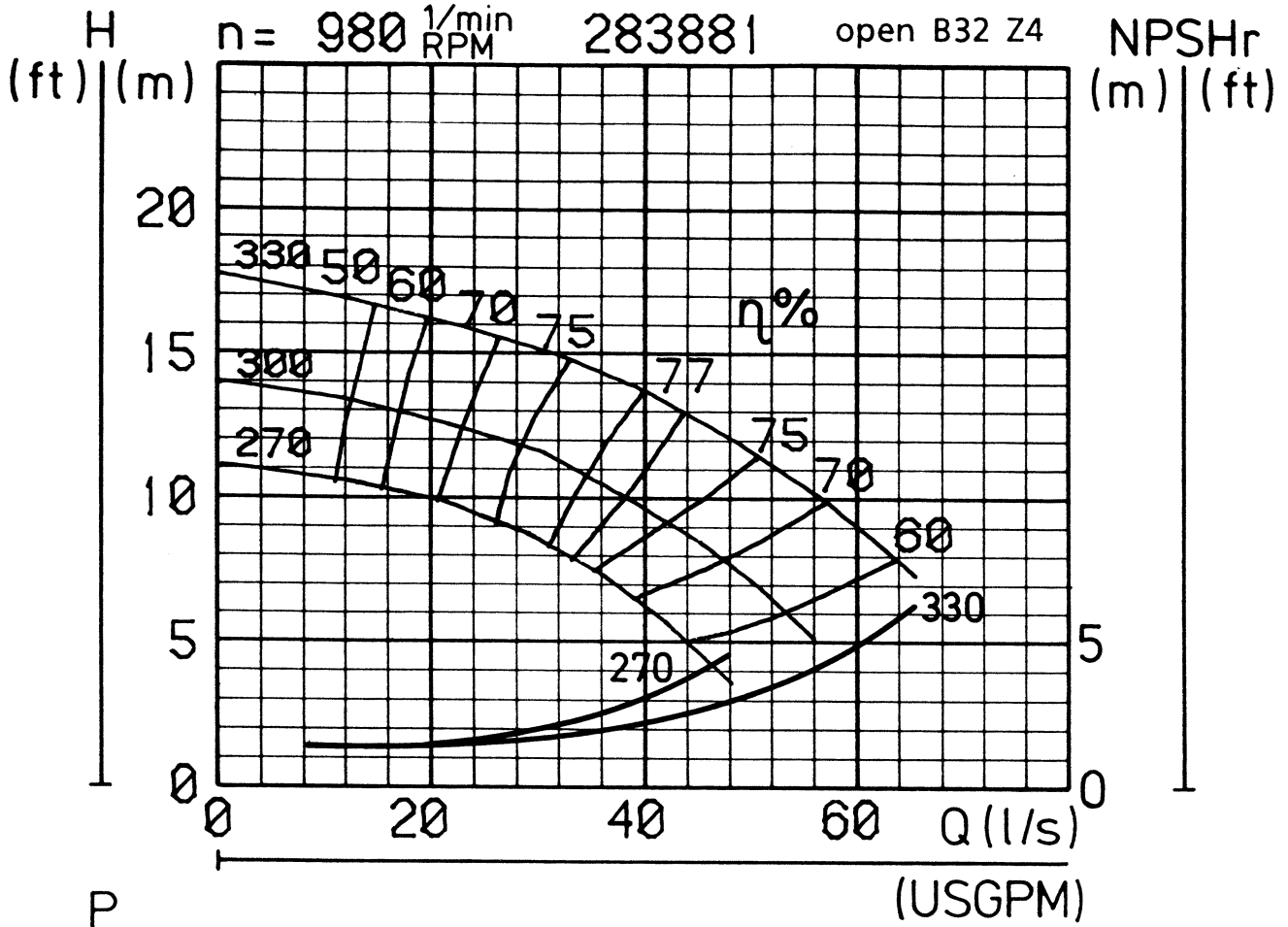

Pump type : <b>APP 32 - 125</b>	Nominal speed : <b>980 rpm</b>	<b>KSB</b> 
Curve no. : K 00461	Frequency : <b>50 Hz</b>	



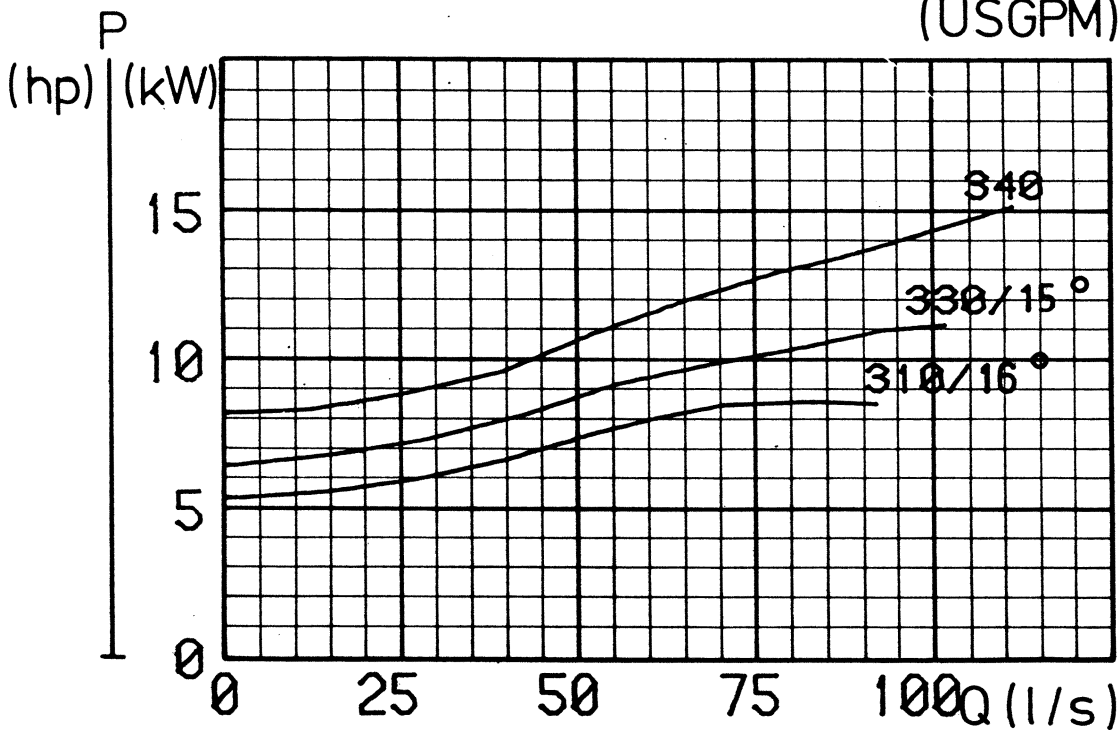
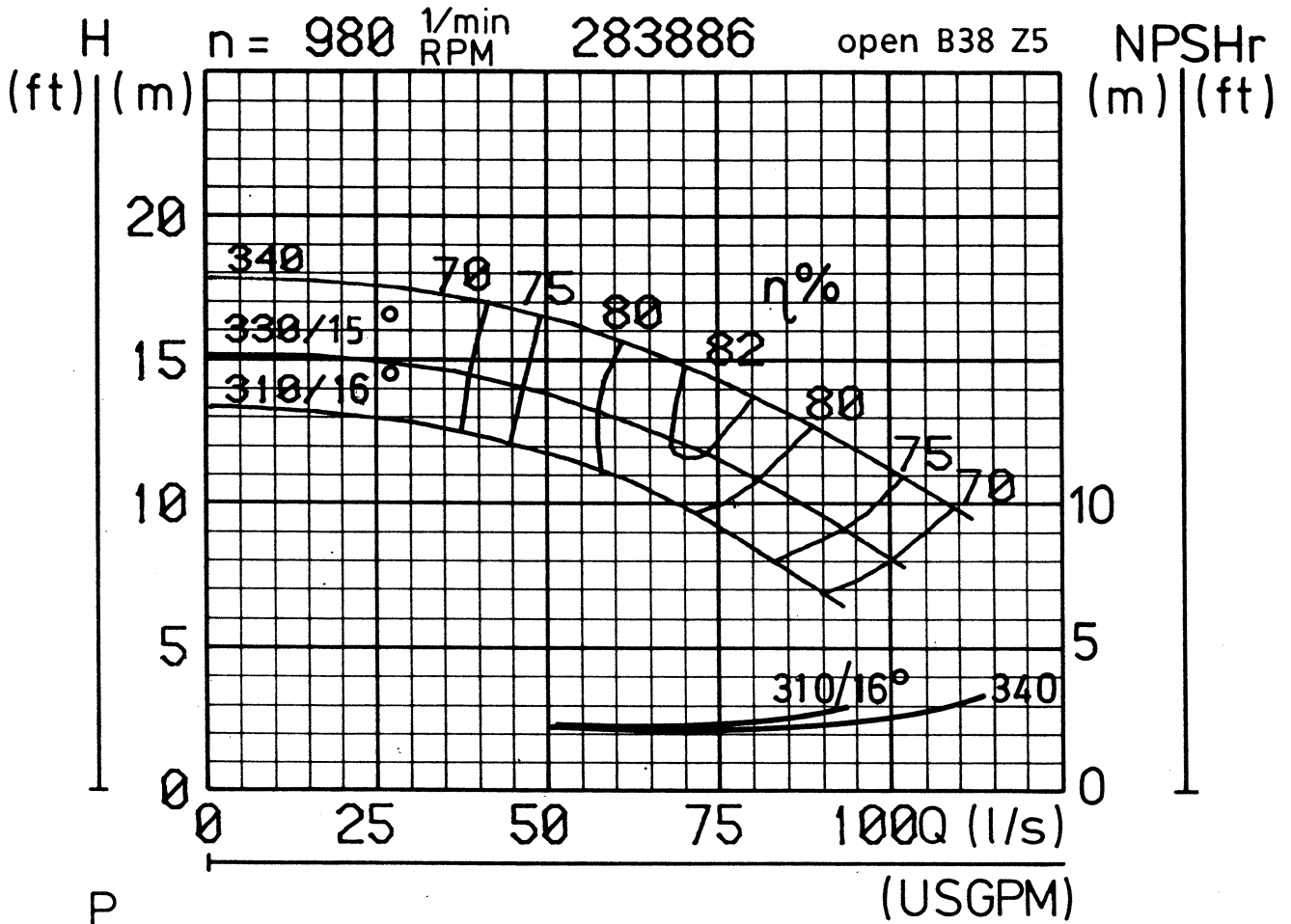

Pump type : <b>APP 42 - 150</b>	Nominal speed : <b>980 rpm</b>	
Curve no. : K 00710	Frequency : <b>50 Hz</b>	



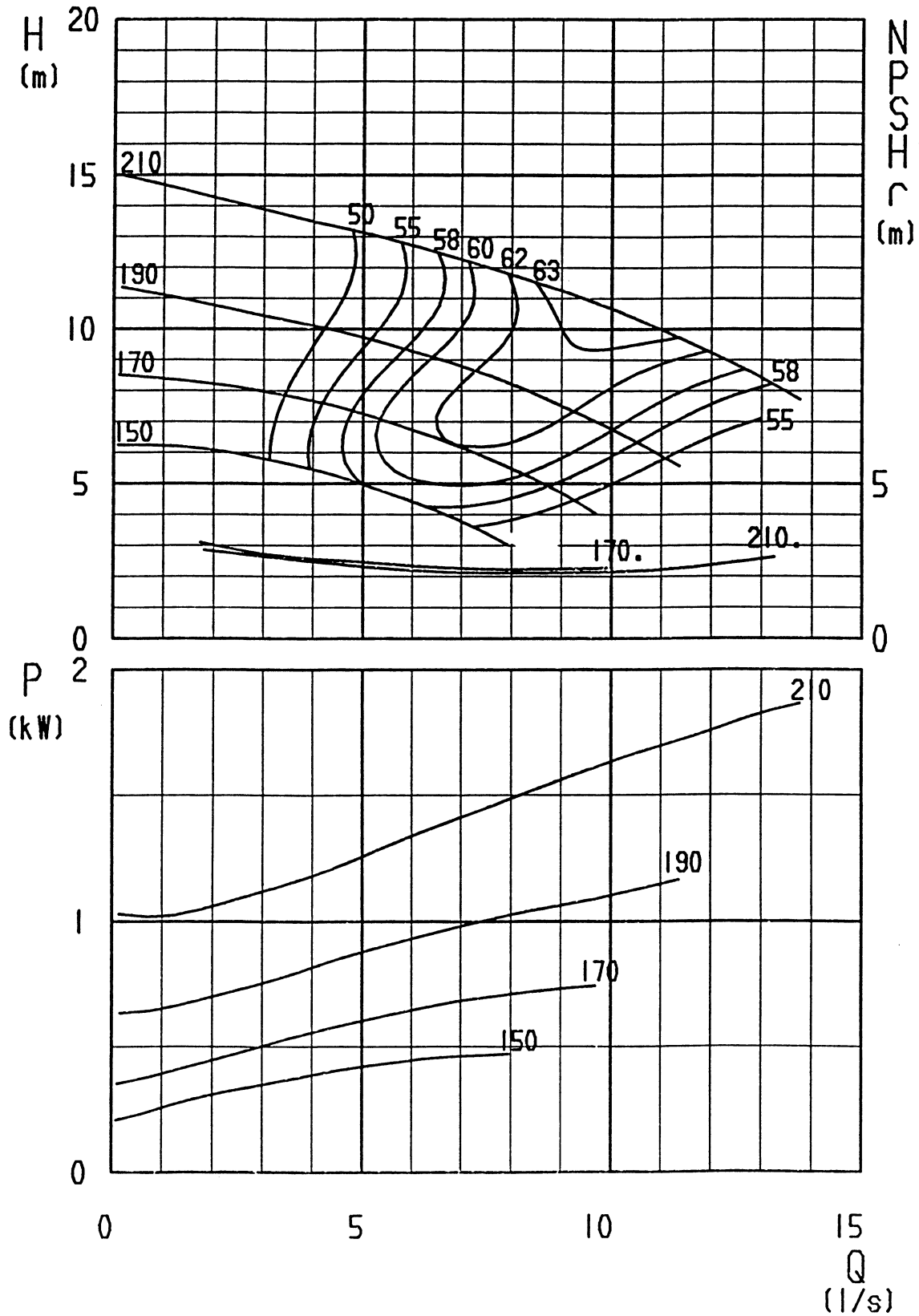

Pump type : <b>APP 11 - 50</b>	Nominal speed : <b>1430 rpm</b>	<b>KSB</b> 
Curve no. : K 000410	Frequency : <b>50 Hz</b>	

$n = 1430 \text{ rpm}$



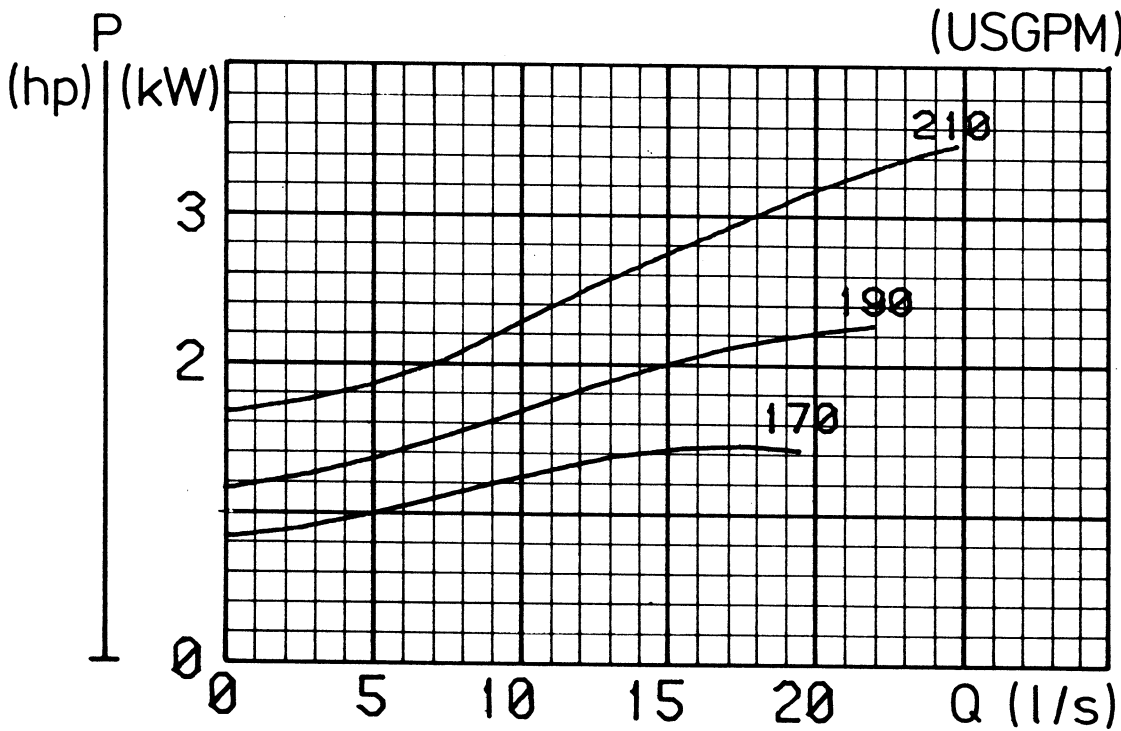
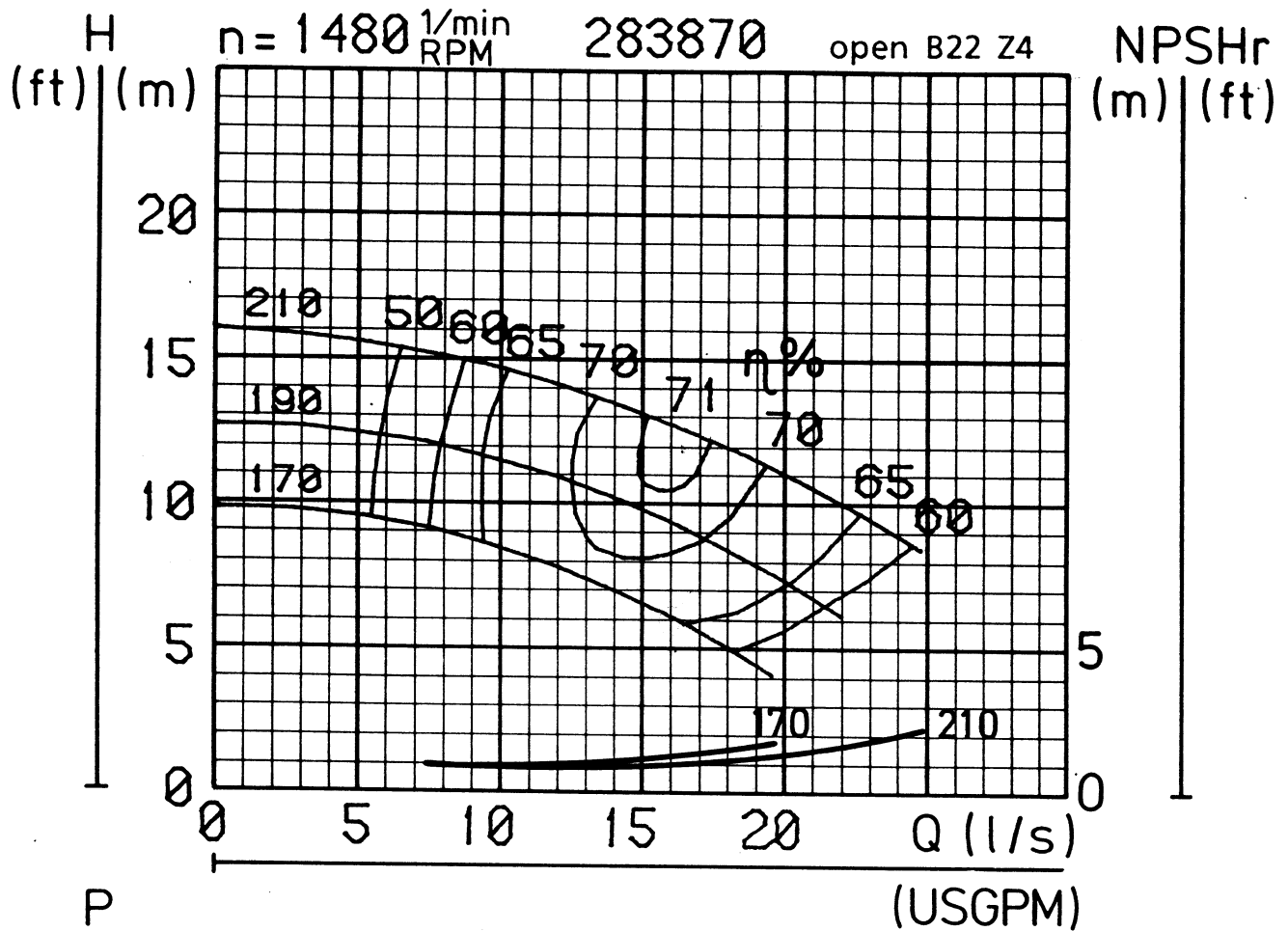

Pump type : APP 21 - 65	Nominal speed : 1480 rpm	
Curve no. : K 00414	Frequency : 50 Hz	

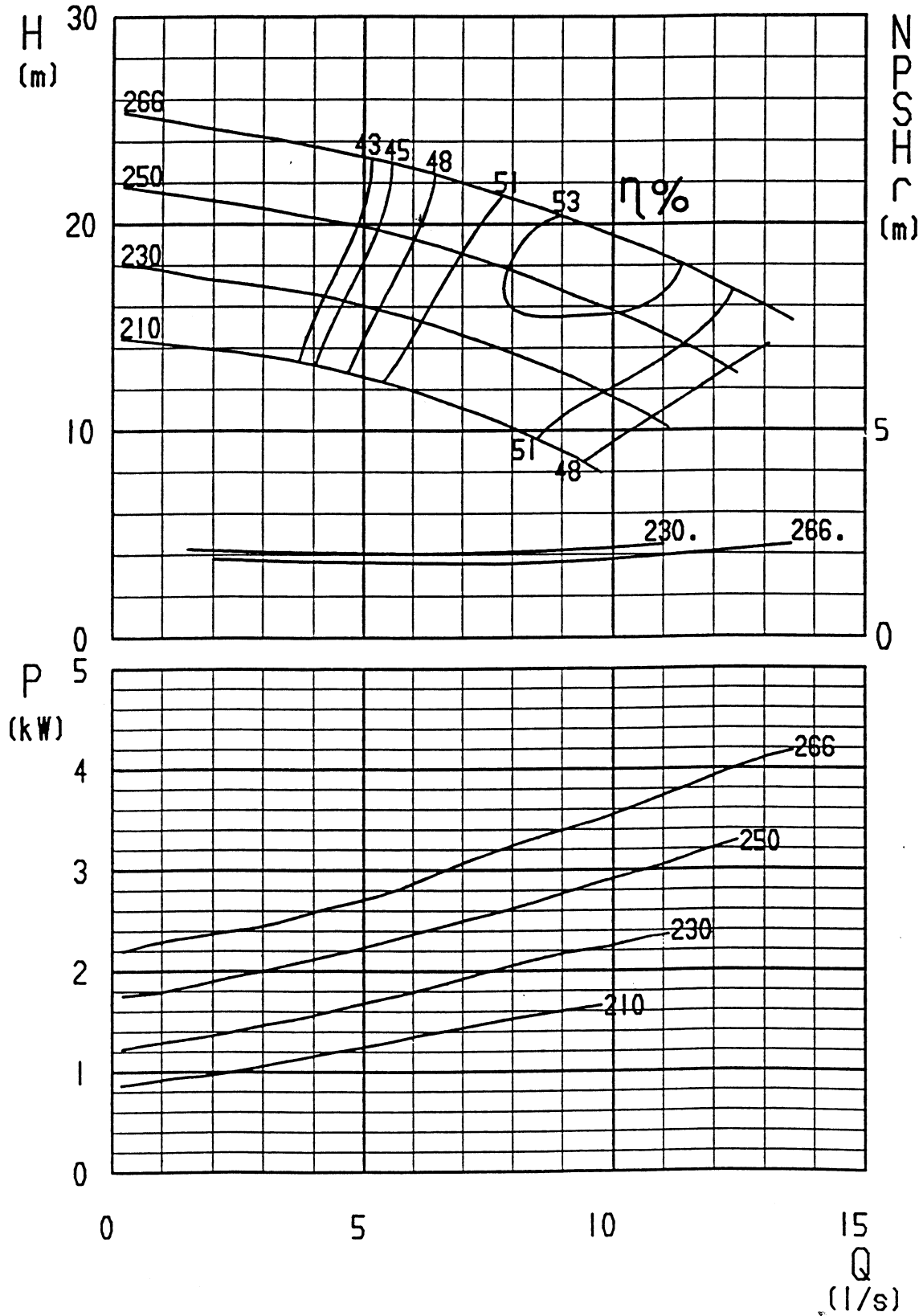

Pump type : <b>APP 22 - 50</b>	Nominal speed : <b>1480 rpm</b>	
Curve no. : K 000422	Frequency : <b>50 Hz</b>	

$n = 1480 \text{ rpm}$



Pump type : <b>APP 22 - 65</b>	Nominal speed : <b>1480 rpm</b>	
Curve no. : K 000426	Frequency : <b>50 Hz</b>	

$n = 1480 \text{ rpm}$

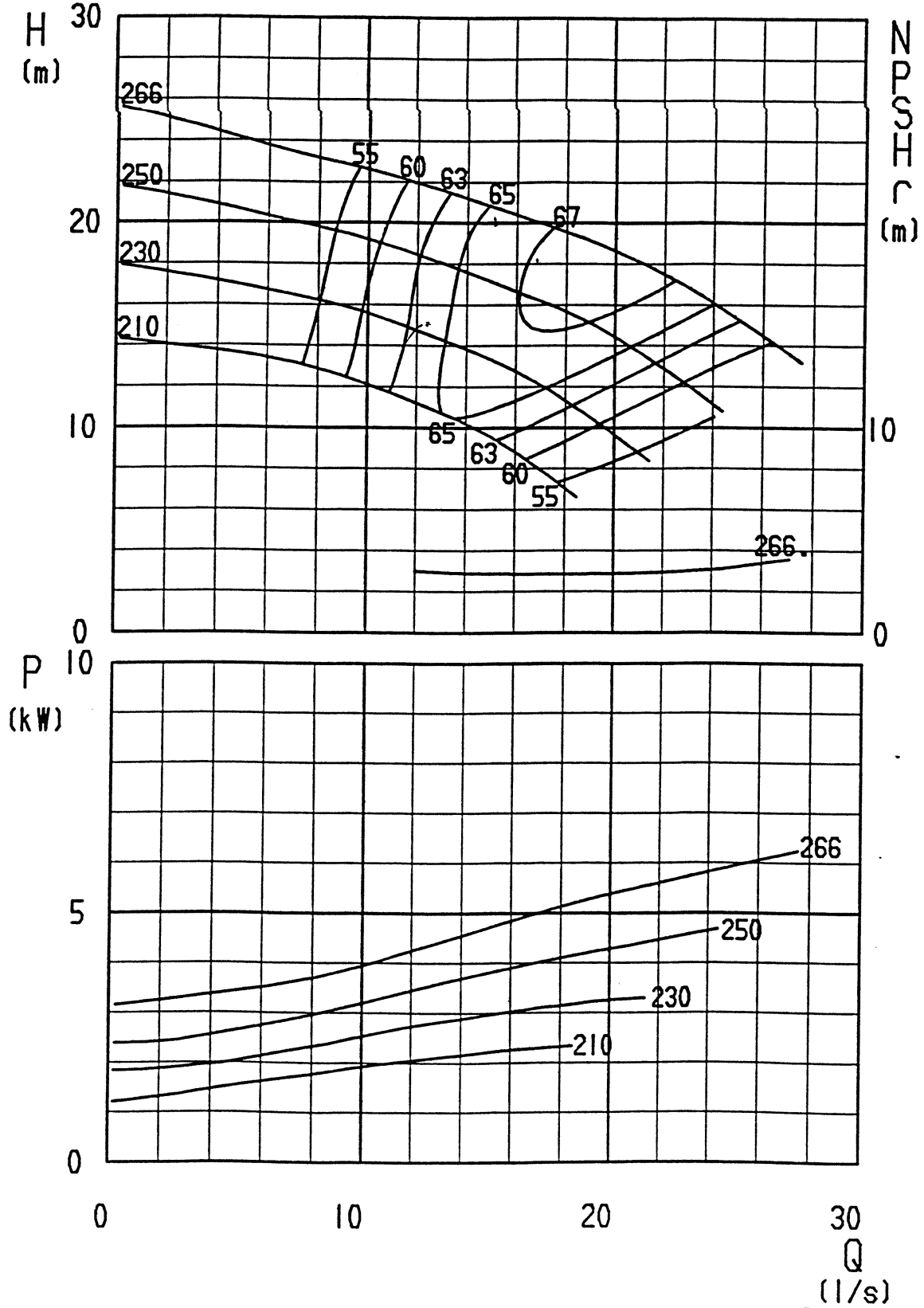

Pump type : <b>APP 22 - 80</b>	Nominal speed : <b>1480 rpm</b>	
Curve no. : K 000430	Frequency : <b>50 Hz</b>	

$n = 1480 \text{ rpm}$

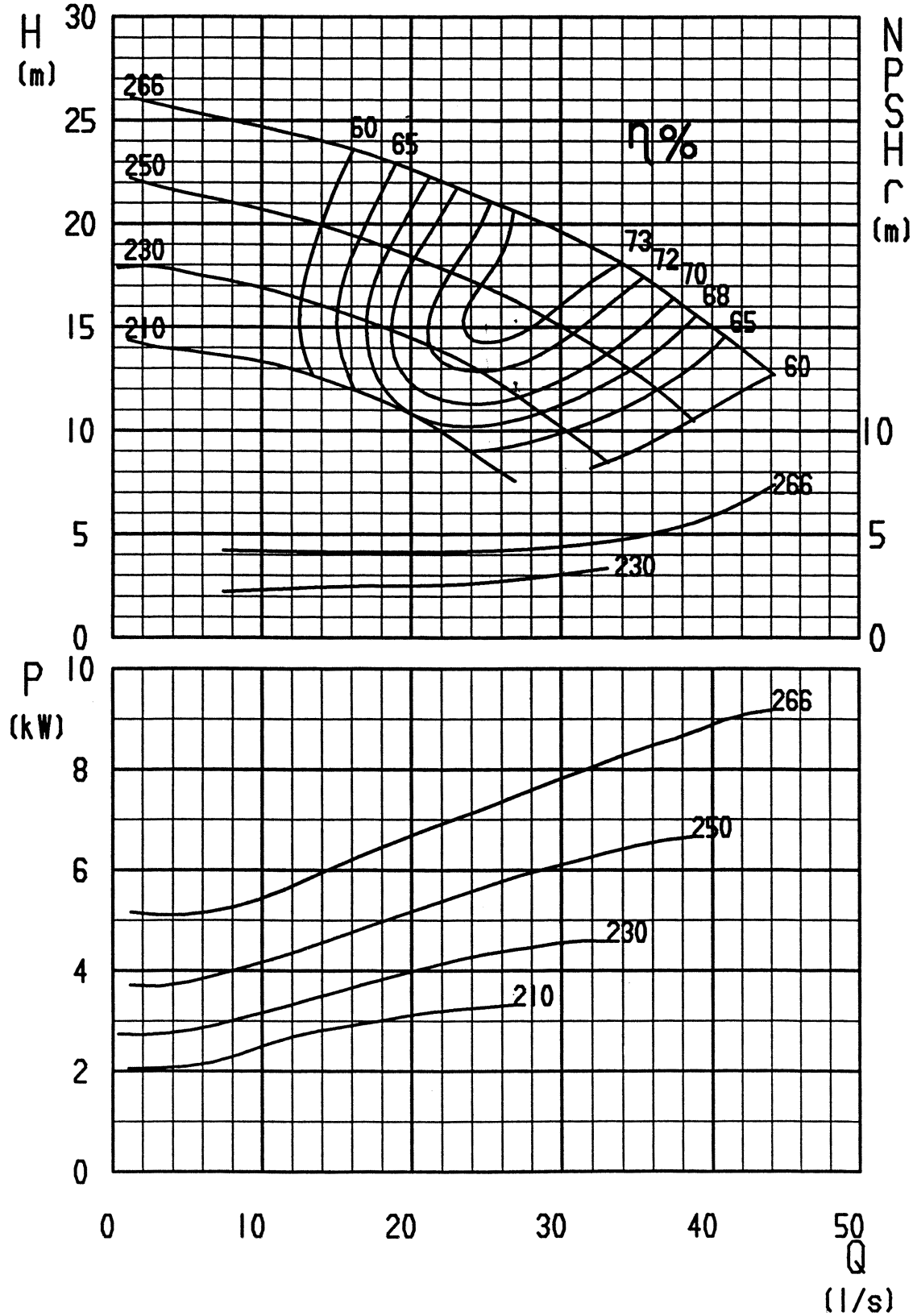

Pump type : <b>APP 31 - 100</b>	Nominal speed : <b>1480 rpm</b>	
Curve no. : K 00436	Frequency : <b>50 Hz</b>	

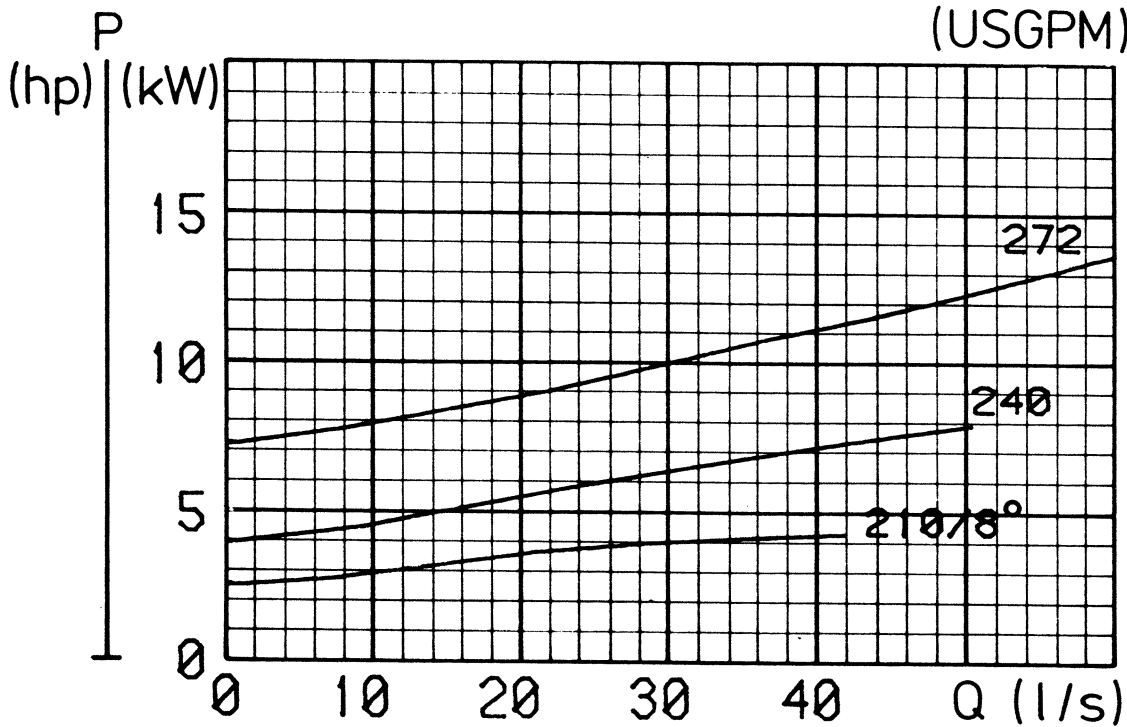
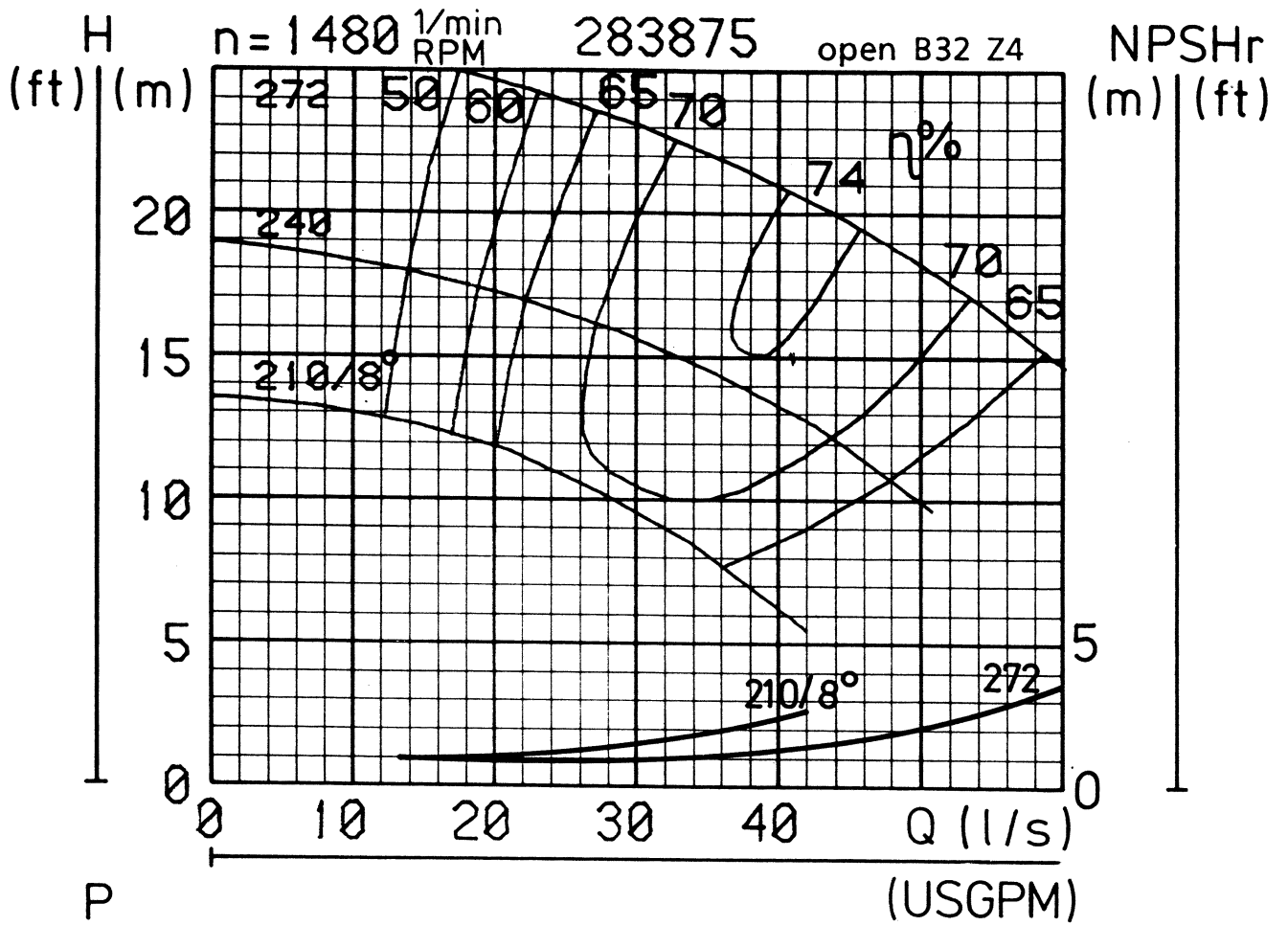

Pump type : <b>APP 31 - 150</b>	Nominal speed : <b>1480 rpm</b>	<b>KSB</b> 
Curve no. : <b>K 00448</b>	Frequency : <b>50 Hz</b>	

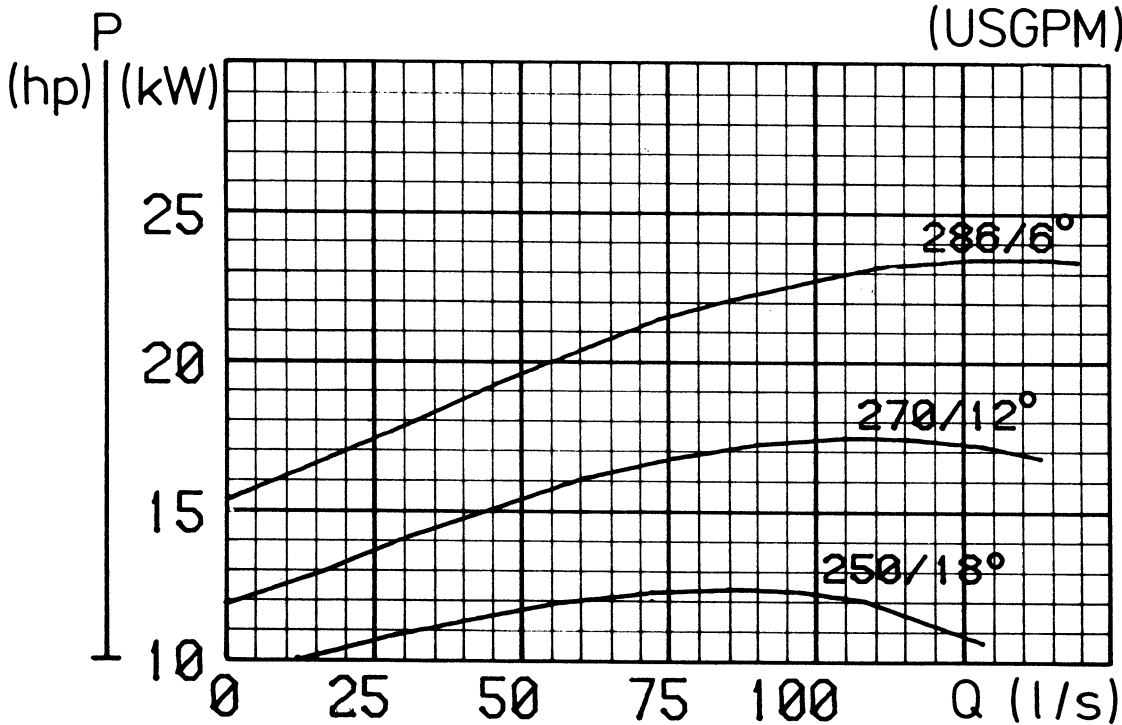
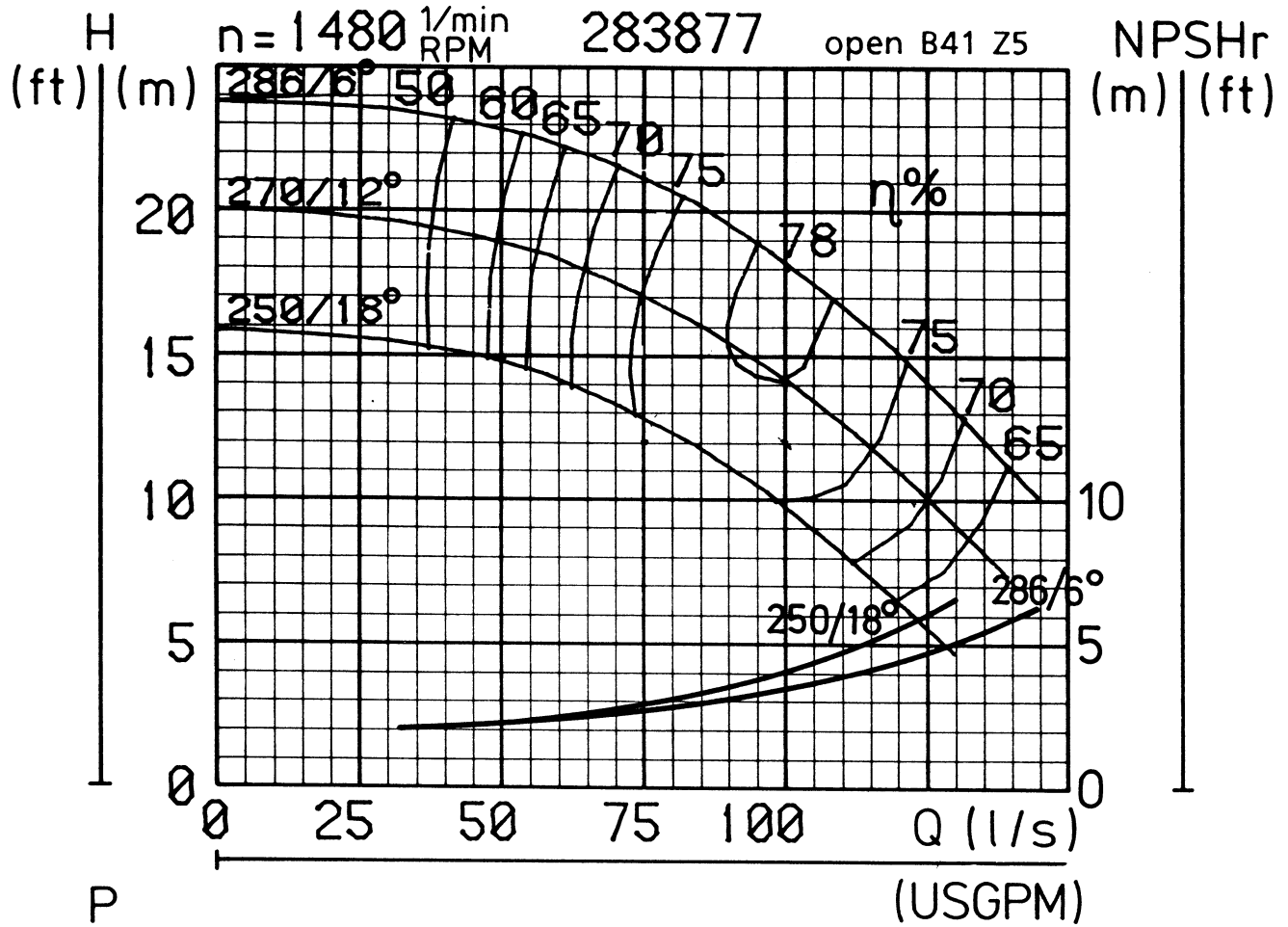

Pump type : <b>APP 32 - 65</b>	Nominal speed : <b>1480 rpm</b>	
Curve no. : <b>K 00450</b>	Frequency : <b>50 Hz</b>	

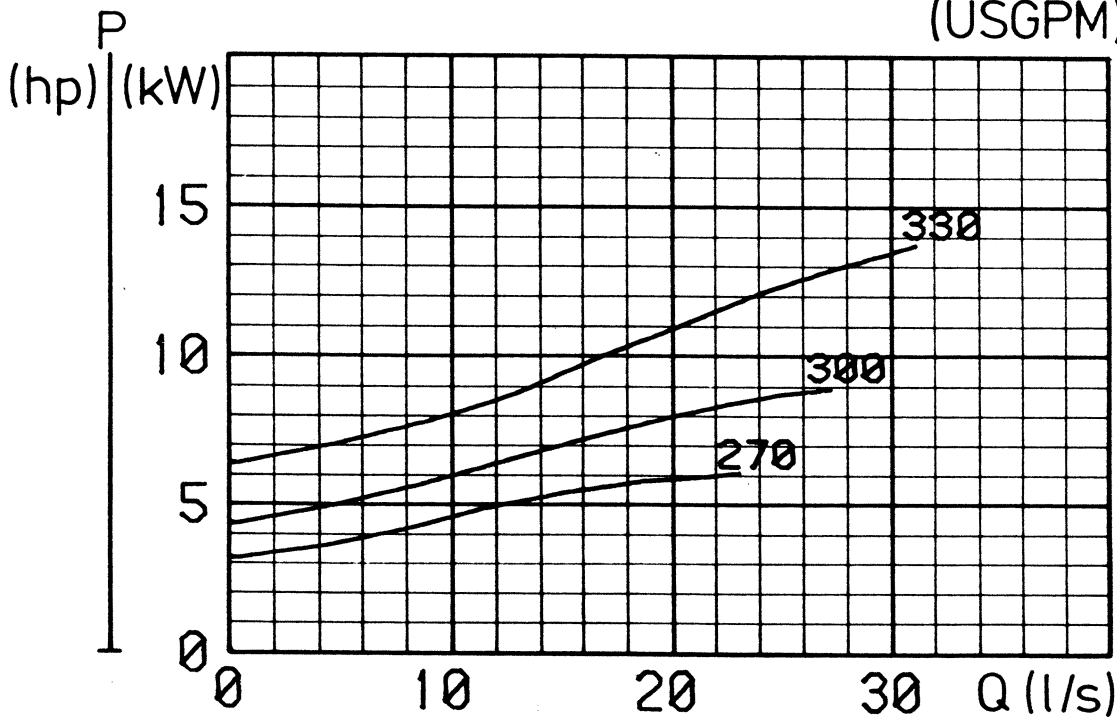
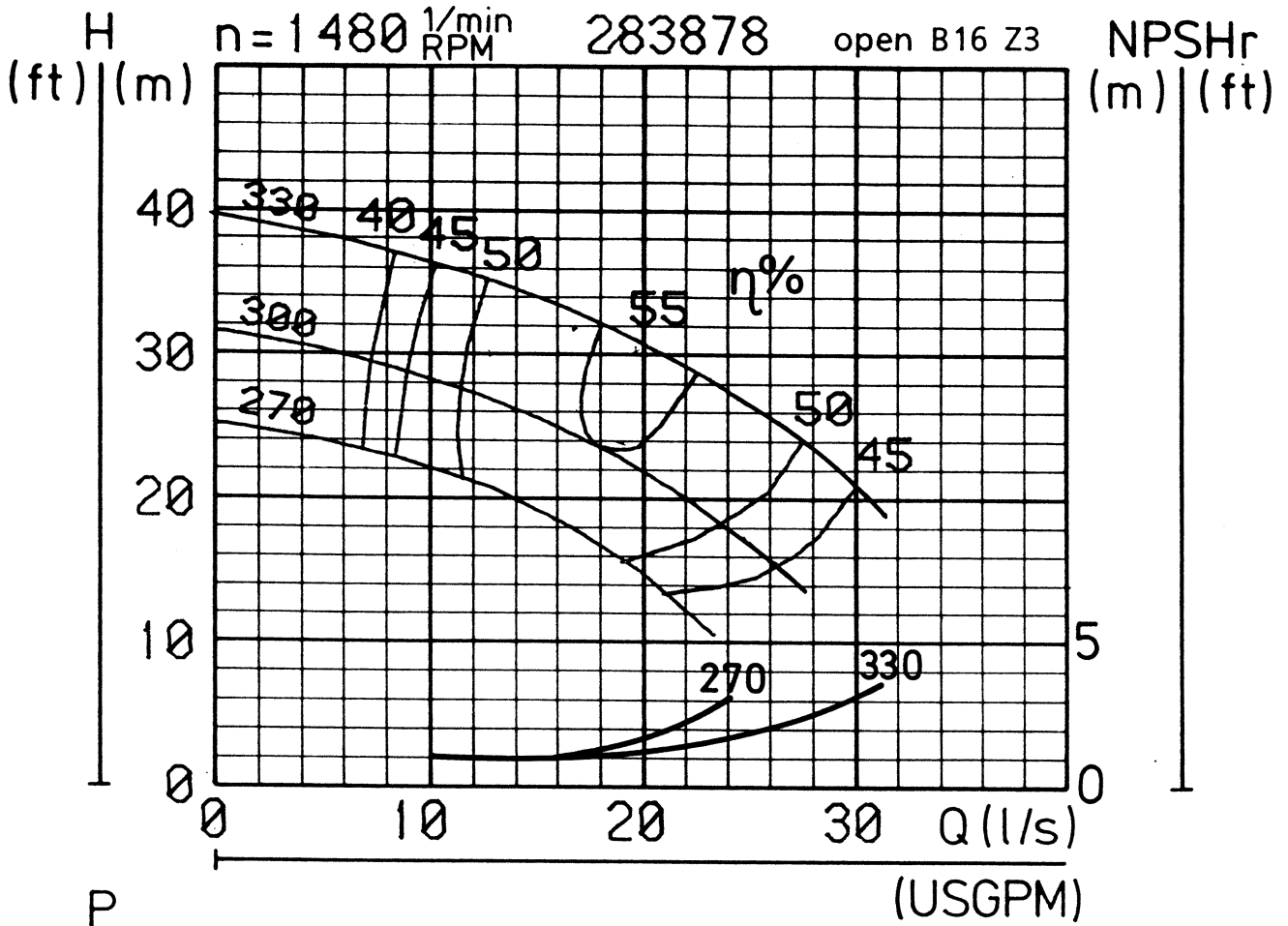

Pump type : APP 32 - 80	Nominal speed : 1480 rpm	
Curve no. : K 00453	Frequency : 50 Hz	

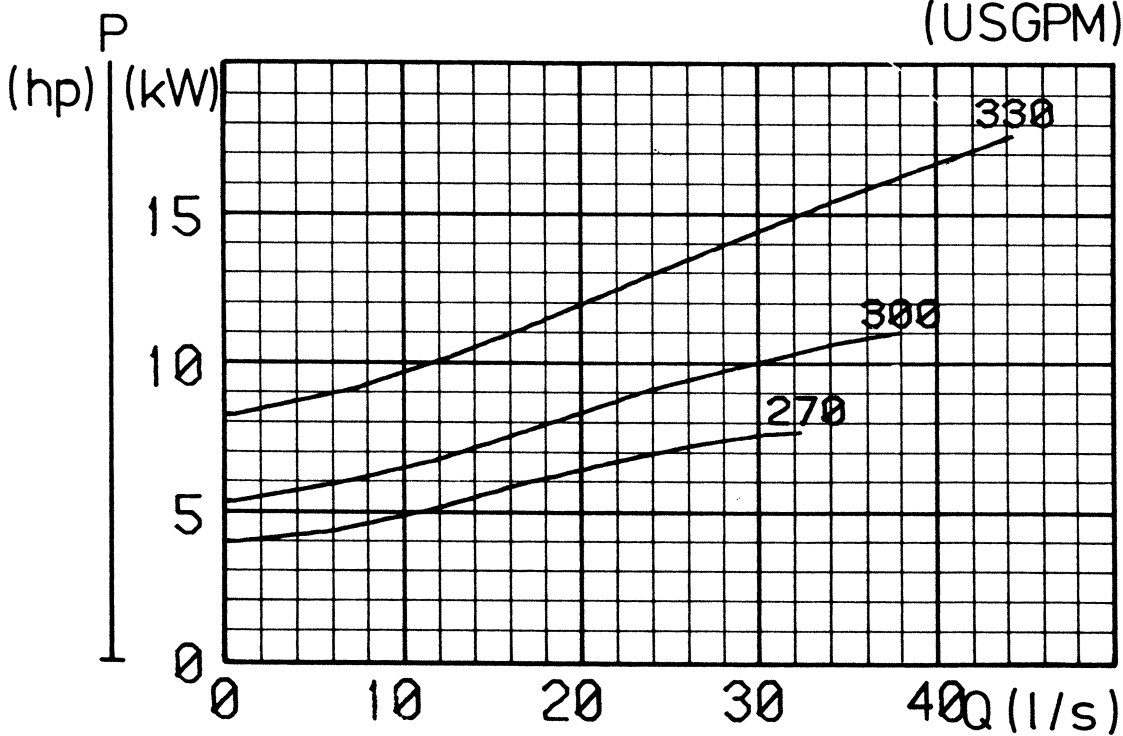
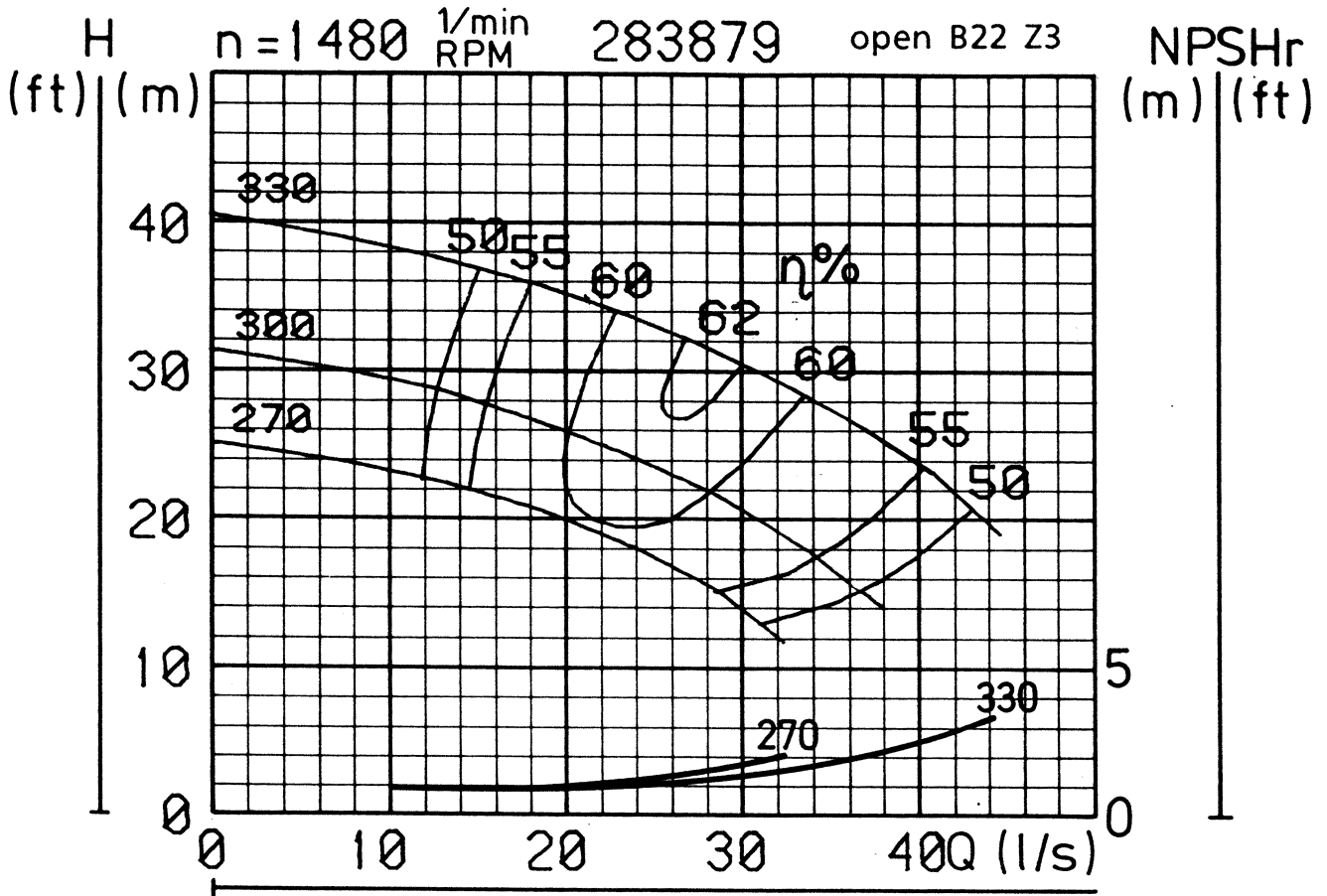

$d_2$
330
325
320
315
310
305
300
295
290
285
280
275
270
265

Pump type : <b>APP 32 - 100</b>	Nominal speed : <b>1480 rpm</b>	
Curve no. : K 000457	Frequency : <b>50 Hz</b>	

$n = 1480 \text{ rpm}$

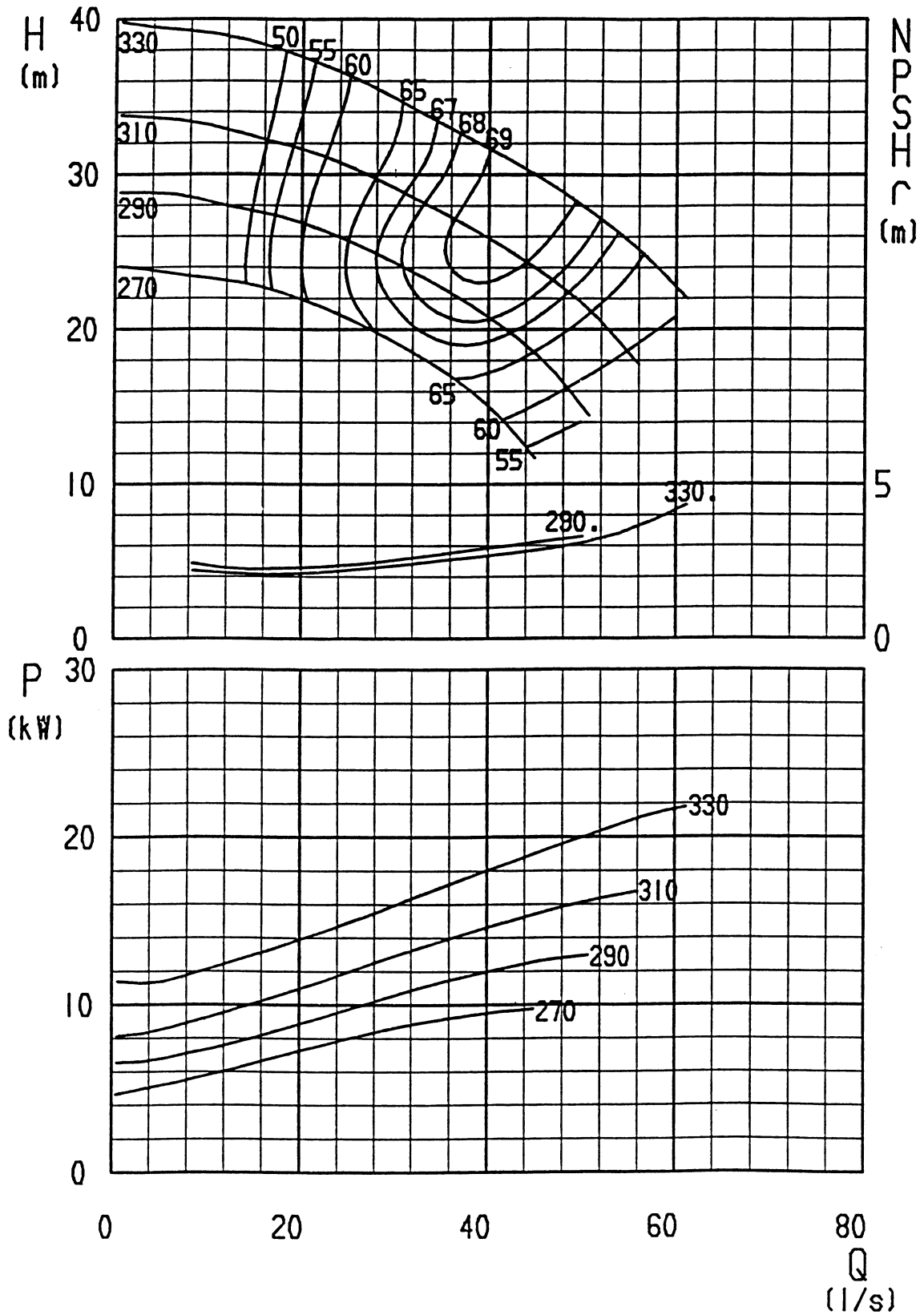

Pump type : APP 32 - 125	Nominal speed : 1480 rpm	
Curve no. : K 00464	Frequency : 50 Hz	

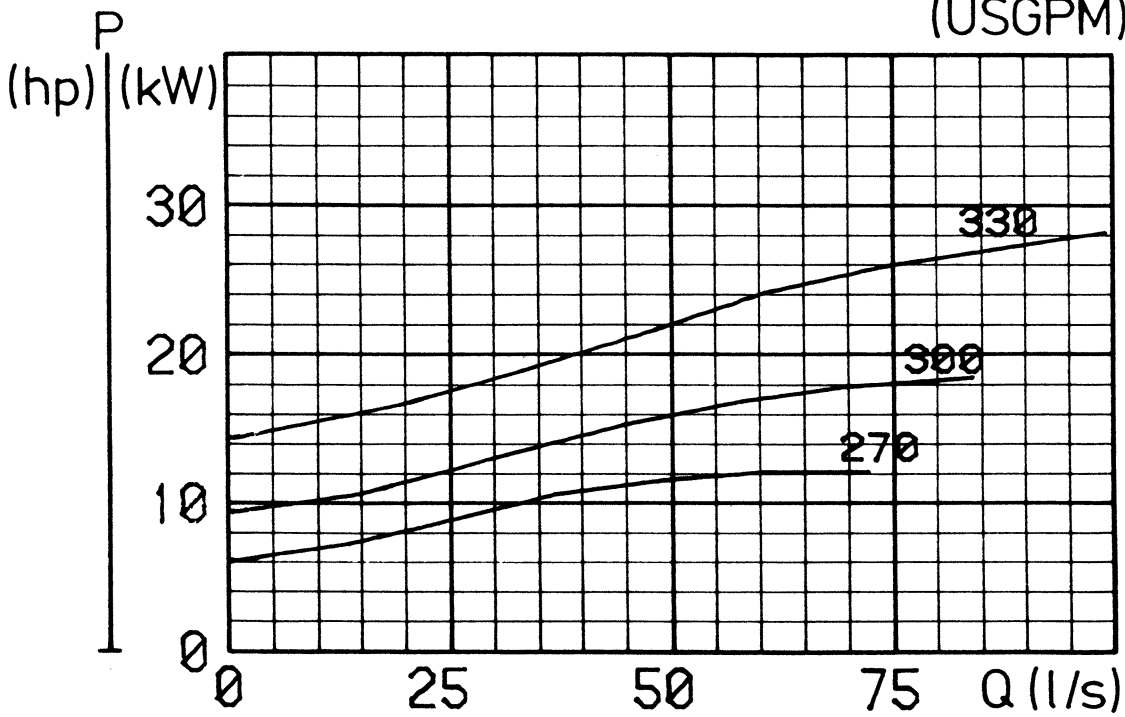
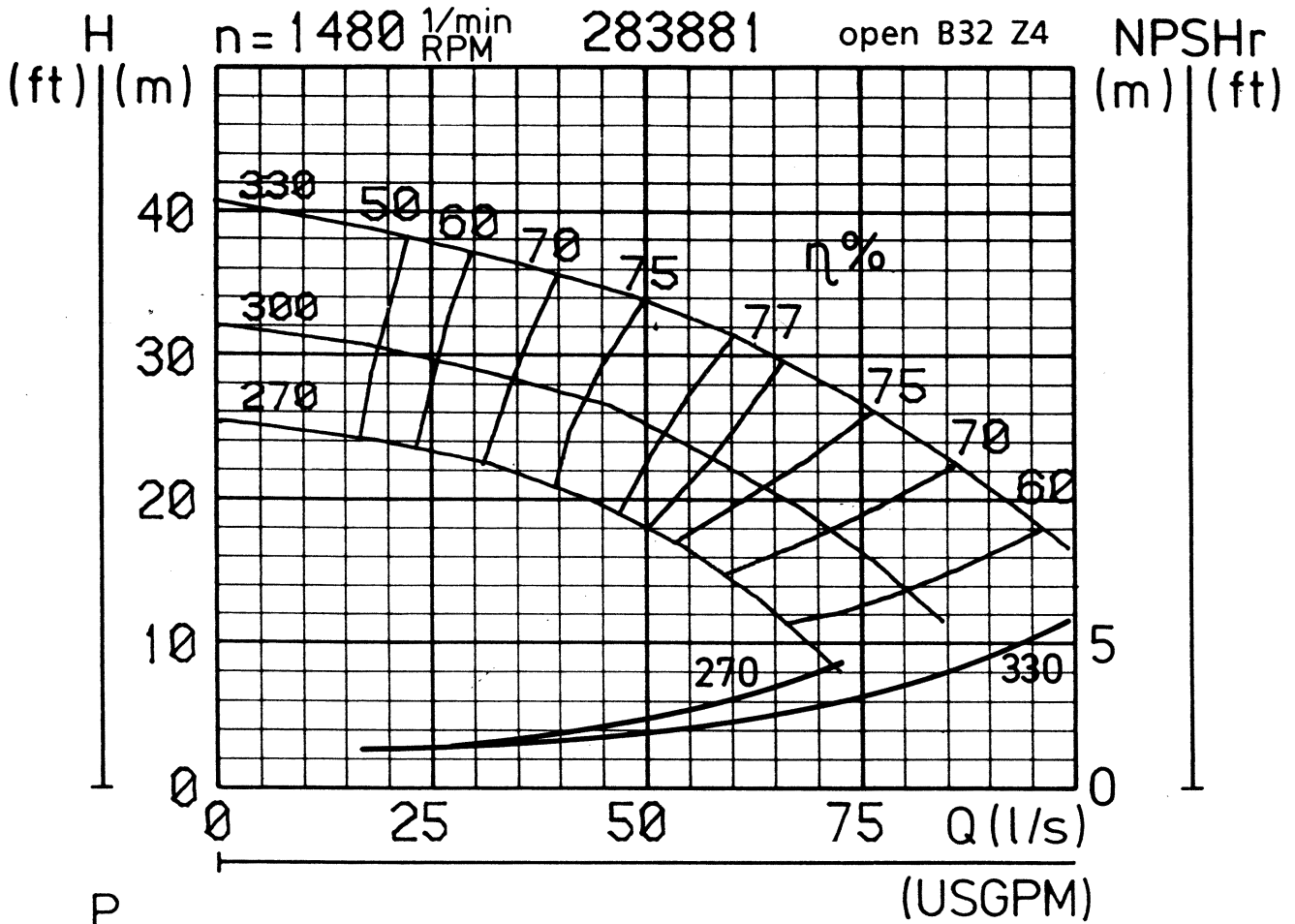

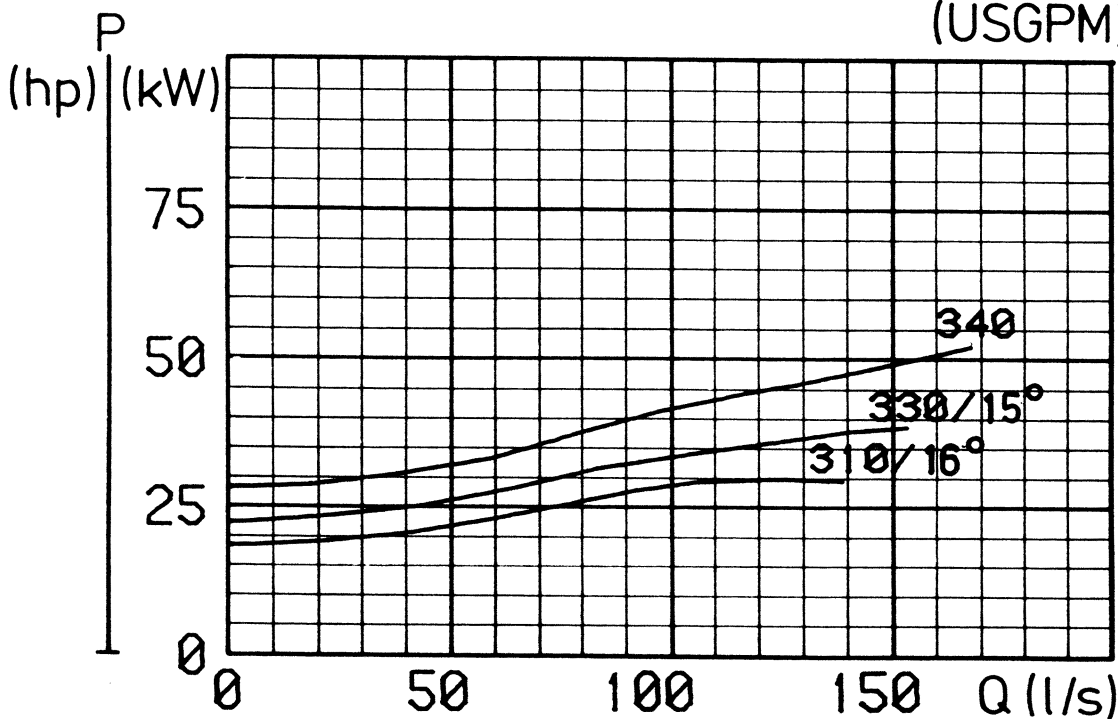
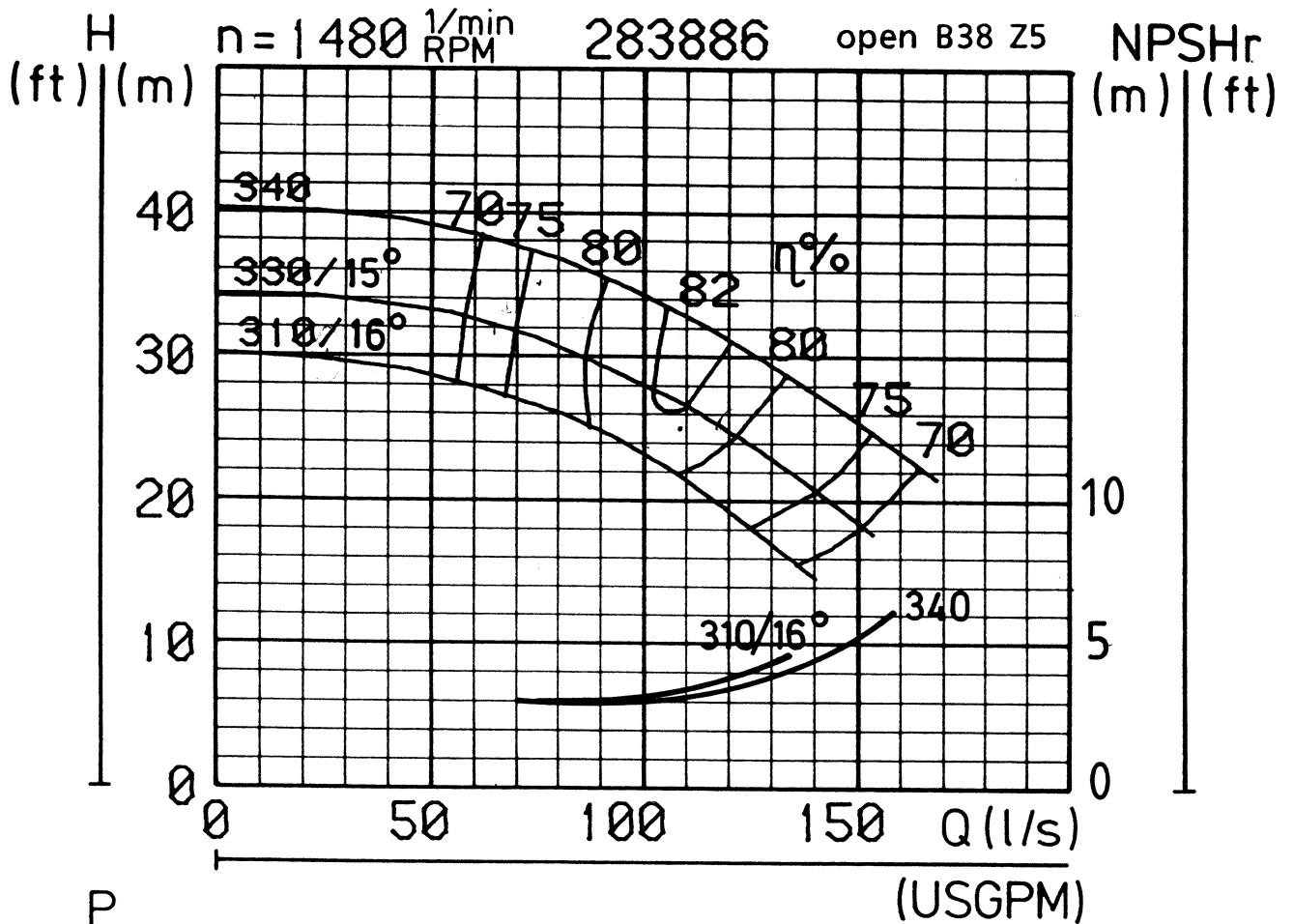

Pump type : <b>APP 42 - 150</b>	Nominal speed : <b>1480 rpm</b>	
Curve no. : <b>K 00712</b>	Frequency : <b>50 Hz</b>	



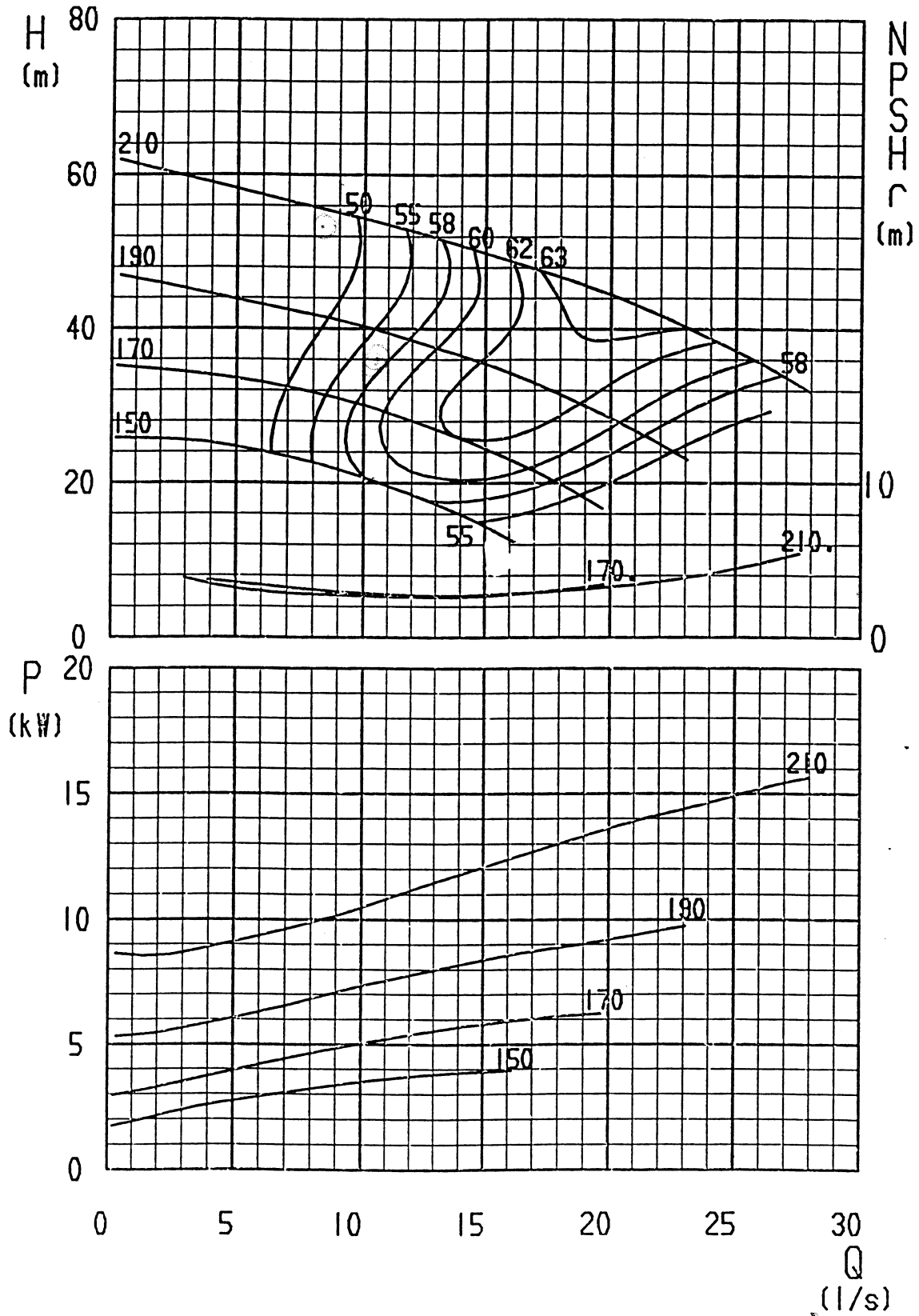

Pump type : <b>APP 11 - 50</b>	Nominal speed : <b>2905 rpm</b>	<b>KSB</b> 
Curve no. : K 000412	Frequency : <b>50 Hz</b>	

$n = 2905 \text{ rpm}$



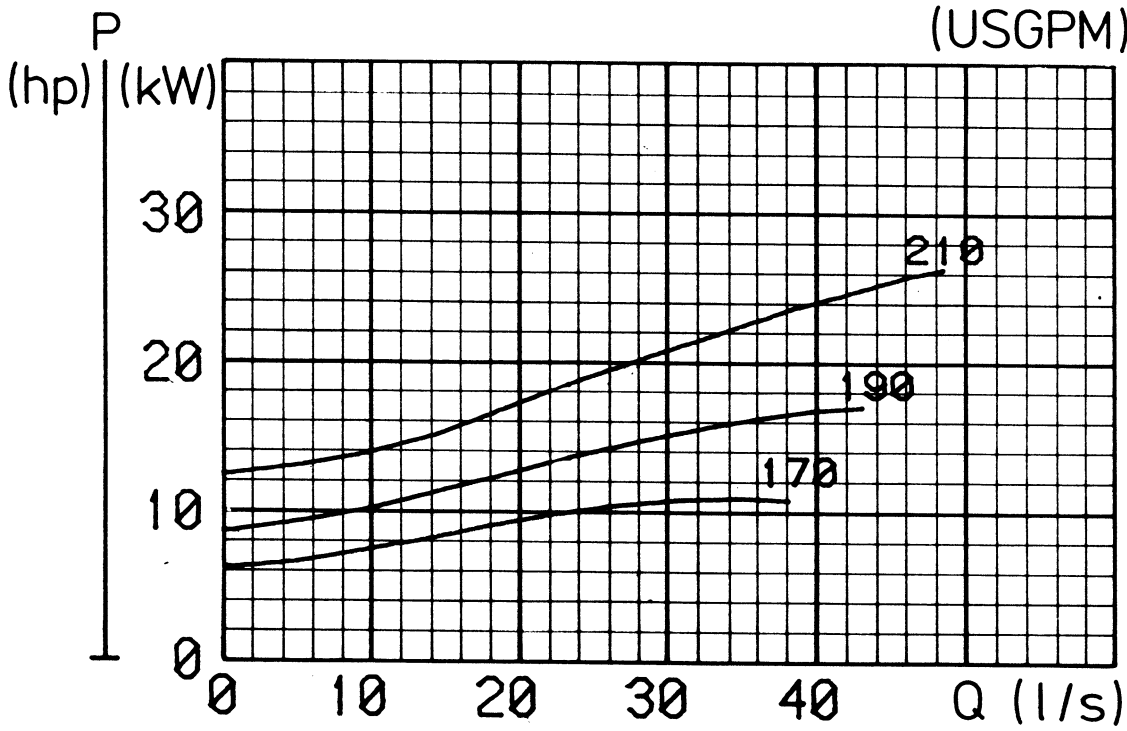
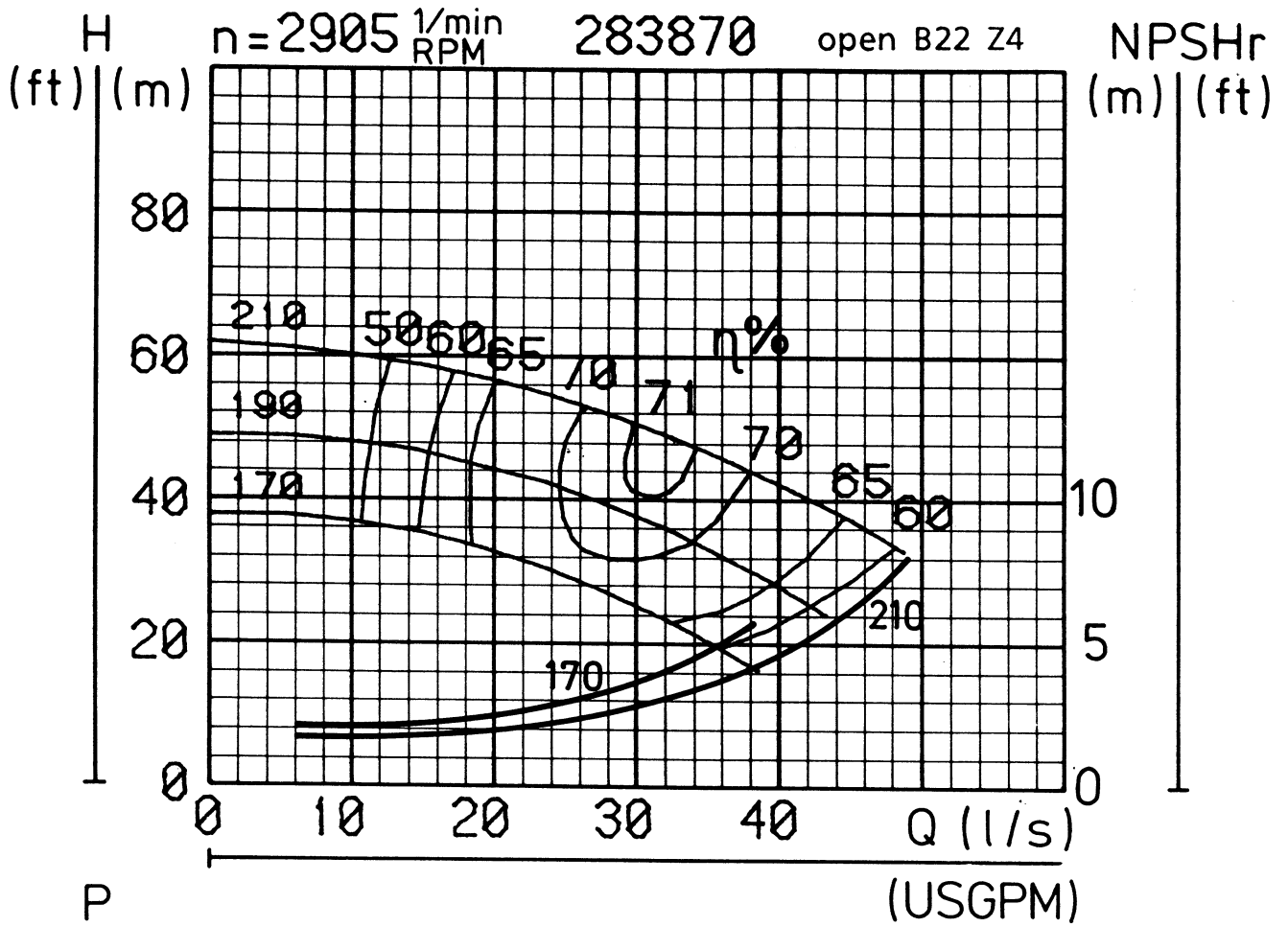

Pump type : <b>APP 21 - 65</b>	Nominal speed : <b>2905 rpm</b>	
Curve no. : K 00416	Frequency : <b>50 Hz</b>	

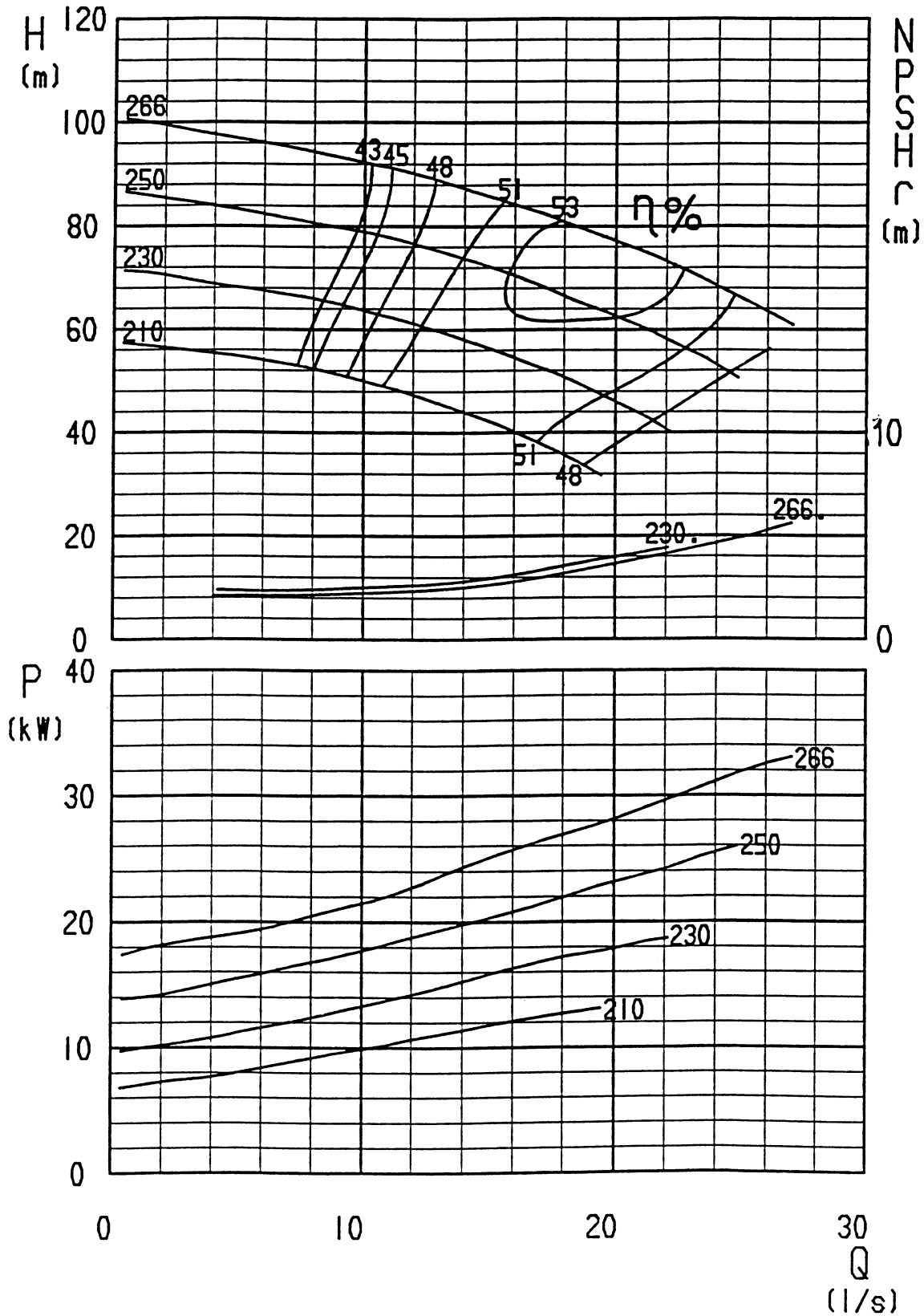

Pump type : <b>APP 22 - 50</b>	Nominal speed : <b>2950 rpm</b>	
Curve no. : K 000424	Frequency : <b>50 Hz</b>	

$n = 2950 \text{ rpm}$



Pump type : <b>APP 22 - 65</b>	Nominal speed : <b>2950 rpm</b>	
Curve no. : K 000428	Frequency : <b>50 Hz</b>	

$n = 2950 \text{ rpm}$

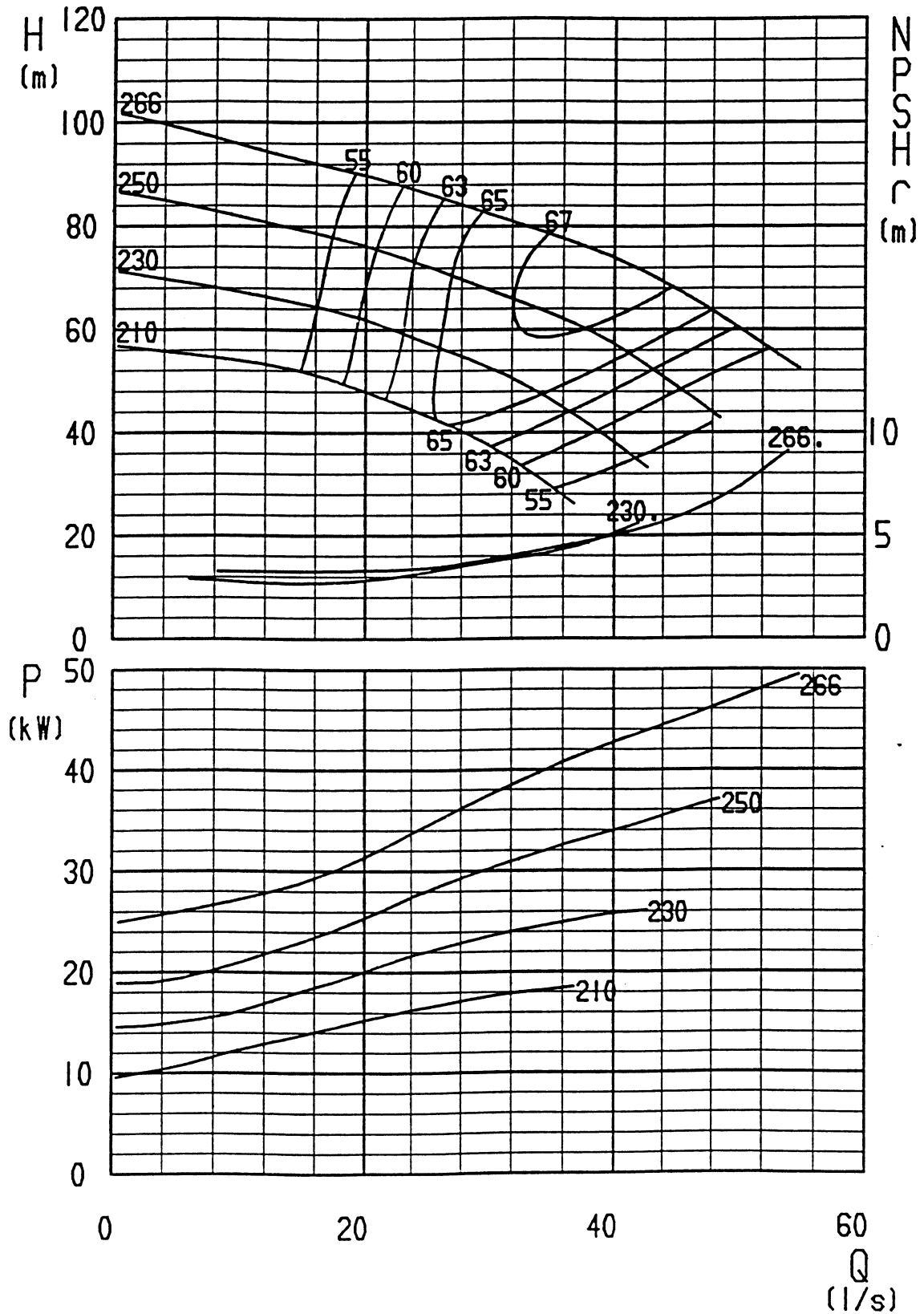

Pump type : <b>APP 22 - 80</b>	Nominal speed : <b>2950 rpm</b>	
Curve no. : K 000433	Frequency : <b>50 Hz</b>	

$n = 2950 \text{ rpm}$

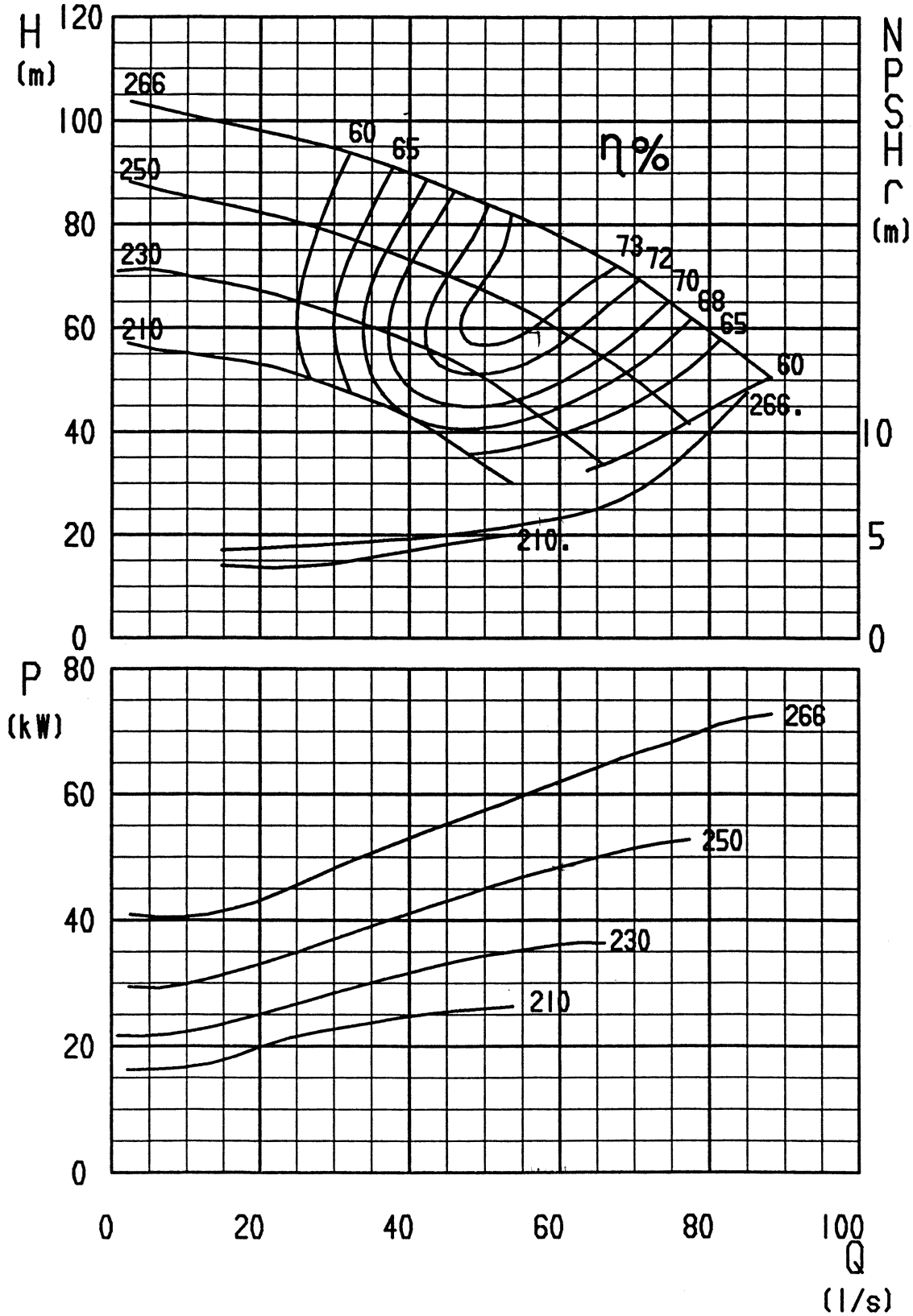

Pump type : <b>APP 31 - 100</b>	Nominal speed : <b>2950 rpm</b>	
Curve no. : K 00438	Frequency : <b>50 Hz</b>	

